

PRINCETON UNIVERSITY

**Ph501**

**Electrodynamics**

**Problem Set 7**

Kirk T. McDonald

(2001)

kirkmcd@princeton.edu

<http://physics.princeton.edu/~mcdonald/examples/>

### 1. Polarization Dependence of Emissivity

Deduce the emissive power  $P_\nu$  of radiation of frequency  $\nu$  into vacuum at angle  $\theta$  to the normal to the surface of a good conductor at temperature  $T$ , for polarization both parallel and perpendicular to the plane of emission.

Recall Kirchhoff's law of heat radiation (as clarified by Planck, *The Theory of Heat Radiation*, chap. II, especially sec. 28) that

$$\frac{P_\nu}{A_\nu} = K(\nu, T) = \frac{h\nu^3/c^2}{e^{h\nu/kT} - 1}, \quad (1)$$

where  $P_\nu$  is the emissive power per unit area per unit frequency interval (emissivity) and

$$A_\nu = 1 - \mathcal{R} = 1 - \left| \frac{E_{0r}}{E_{0i}} \right|^2 \quad (2)$$

is the absorption coefficient ( $0 \leq A_\nu \leq 1$ ),  $c$  is the speed of light,  $h$  is Planck's constant and  $k$  is Boltzmann's constant.

## 2. Rayleigh Resistance

A circular wire of conductivity  $\sigma$  and radius  $a \ll d$ , where  $d(\omega) \ll \lambda$  is the skin depth, carries current that varies as  $I(t) = I_0 e^{-i\omega t}$ . As in prob. 9, set 6, consider the time-averaged Poynting vector at the surface of the wire. Relate this to the Joule loss  $\langle I^2 R \rangle$  to show that

$$R(\omega) = \frac{a}{2d} R_0, \quad \text{where} \quad R_0 = \frac{1}{\pi a^2 \sigma} \quad \text{is the dc resistance per unit length.} \quad (3)$$

### 3. Telegrapher's Equation

Deduce the differential equation for current (or voltage) in a two-conductor transmission line that is characterized by resistance  $R$  (summed over both conductors), inductance  $L$ , capacitance  $C$  and leakage conductivity  $K$ , all defined per unit length. The leakage conductivity describes the undesirable current that flows directly from one conductor to the other across the dielectric that separate them according to

$$I_{\text{leakage}} = KV, \quad (4)$$

where  $V(x, t)$  is the voltage between the two conductors, taken to be along the  $x$  axis.

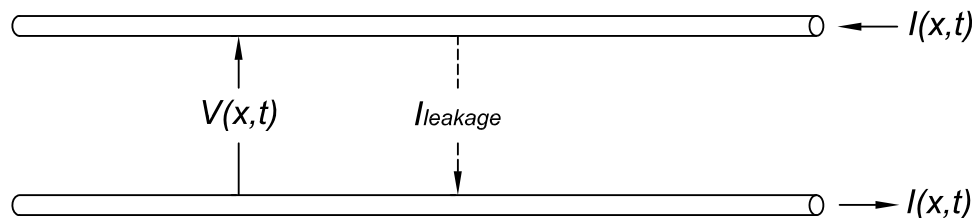

Deduce a relation among  $R$ ,  $L$ ,  $C$  and  $K$  that permits 'distortionless' waves of the form

$$e^{-\gamma x} f(x - vt) \quad (5)$$

to propagate along the transmission line. Give expressions for  $v$  and  $\gamma$  in terms of  $R$ ,  $L$  and  $C$ ; relate  $\gamma$  to the transmission line impedance defined by  $Z = V/I$  in the limit that  $R$  and  $K$  vanish.

4. **Transmission Line Impedance**

a) Consider a two-wire transmission line with zero resistance (and zero leakage current) that lies along the  $z$  axis in vacuum. We define the line impedance  $Z$  by  $V = ZI$ , where  $I(z, t)$  is the current in each of the wires ( $+I$  in one,  $-I$  in the other), and  $V(z, t)$  is the voltage difference between the two wires. Show that  $Z$  is real ( $\Rightarrow V$  and  $I$  are in phase), and that  $Z = \sqrt{L/C}$ , where  $C$  and  $L$  are the capacitance and inductance per unit length.

b) **Impedance Matching**

A transmission line of impedance  $Z_1$  for  $z < 0$  is connected to a line of impedance  $Z_2$  for  $z > 0$ . A wave  $V_i e^{i(k_1 z - \omega t)}$  is incident from  $z = -\infty$ .

Show that the reflected wave  $V_r e^{-i(k_1 z + \omega t)}$  ( $z < 0$ ) and the transmitted wave  $V_t e^{i(k_2 z - \omega t)}$  ( $z > 0$ ) obey

$$\frac{V_r}{V_i} = \frac{Z_2 - Z_1}{Z_2 + Z_1}, \quad \text{and} \quad \frac{V_t}{V_i} = \frac{2Z_2}{Z_2 + Z_1}. \tag{6}$$

Note the boundary conditions on  $I$  and  $Z$  at  $z = 0$ .

Since  $Z_1$  and  $Z_2$  are real, the transmission line of impedance  $Z_2$  could be replaced by a pure resistance  $R = Z_1$  and no reflection would occur.

Even when line 2 is present, we can avoid a reflection by a kind of “antireflection” coating as discussed in prob. 5, set 6. Another way to deduce this is by consideration of the complex impedance  $Z(z) = V(z)/I(z)$  where  $V$  and  $I$  are the total voltage and total current. If the line for  $z < z_0 < 0$  were replaced by a source whose impedance is exactly  $Z(z_0)$ , then the waves for  $z > z_0$  would be unchanged.

Show that

$$Z(-l) = Z_1 \frac{Z_2 - iZ_1 \tan k_1 l}{Z_1 - iZ_2 \tan k_1 l}. \tag{7}$$

Also show that when  $l = \lambda_1/4$  then  $Z(-l) = Z_1^2/Z_2$ , which is real. Hence, the source at  $z = -l$  could be a transmission line of impedance  $Z_0 = Z_1^2/Z_2$ .

That is, a quarter-wave section of impedance  $Z_1 = \sqrt{Z_0 Z_2}$  matches lines of impedances  $Z_0$  and  $Z_2$  with no reflections.

c) **Impedance Matching with Resistors**

The quarter-wave matching of part b) works only at a single frequency. Impedance matching of transmission lines over a broad range of frequencies can be accomplished with appropriate resistors, as illustrated in the following examples. The key to an analysis is that a transmission line of impedance  $Z$  acts on an input signal like a pure resistance of  $R = Z$  which is connected to ground potential.

Thus, a resistor of value  $R = Z_1 - Z_2$  matches signals that moves from a line of impedance  $Z_1$  into one of impedance  $Z_2 < Z_1$ , as shown below

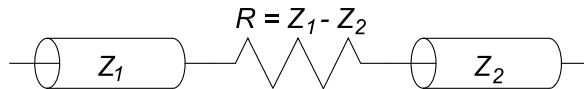

However, if  $Z_1 < Z_2$ , then a matching circuit (for signals moving from line 1 into line 2) can be based on a resistor  $R = Z_1 Z_2 / (Z_2 - Z_1)$  the connects the junction to ground, as shown below.

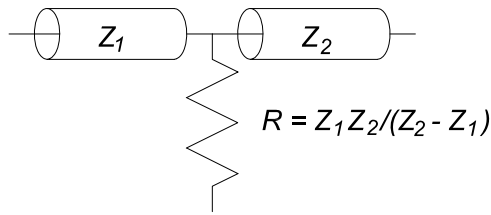

It might be desirable to have a circuit that matches lines 1 and 2 no matter which direction the signals are propagating. This could be accomplished with resistors  $R_1 = \sqrt{Z_1(Z_1 - Z_2)}$  and  $R_2 = Z_2 \sqrt{Z_1 / (Z_1 - Z_2)}$  as shown below, assuming  $Z_1 > Z_2$ .

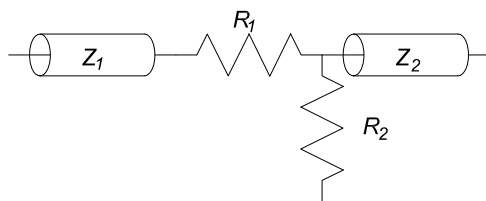

Another type of matching problem involves lines of a single impedance  $Z$ , where it is desired to split the signal into two parts with ratio  $A$  between the currents and voltages. This could be accomplished with resistors  $R_1 = Z/A$  and  $R_2 = AZ$  as shown below.

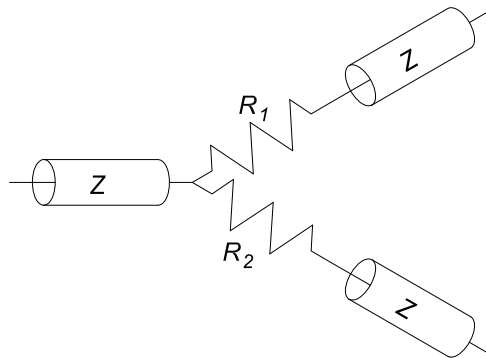

In case of a 1:1 split, then  $R_1 = R_2 = Z$ . In this case, a reflectionless split could also be accomplished with three identical resistors of value  $R = Z/3$  arranged as in the figure below. If these resistors are mounted in a box with three terminals, the split is accomplished properly no matter how the lines are connected.

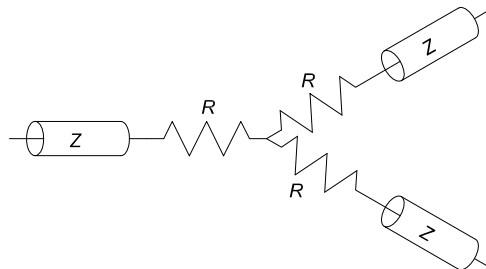

5. In the manufacture of printed circuit boards it is common to construct transmission lines consisting of a “wire” separated from a “ground plane” by a layer of dielectric. Estimate the transmission line impedance for two typical configurations:

a) **Wire over Ground**

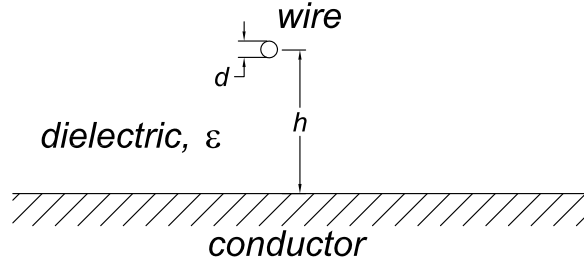

The wire has diameter  $d$ , centered at height  $h \gg d$  above the conducting ground plane. The other space above the ground plane is filled with a dielectric of constant  $\epsilon$  ( $= 4.7$  for G-10, a fiberglass-epoxy composite often used in circuit boards).

Estimate the capacitance  $C$  per unit length, and from this show the transmission line impedance is

$$Z \approx \frac{60 \Omega}{\sqrt{\epsilon}} \ln \frac{4h}{d}. \tag{8}$$

b) **Stripline**

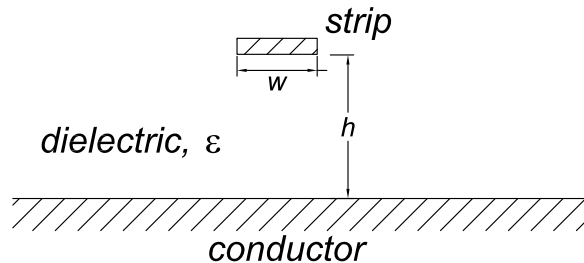

A conducting strip of width  $w$  is at height  $h$  above the conductor.

It may be difficult to estimate the capacitance for  $w \lesssim h$ , so consider the case that  $w \gg h$  to show that

$$Z \approx 377 \Omega \frac{h}{\sqrt{\epsilon w}}. \tag{9}$$

### 6. Off-Center Coaxial Cable

A “coaxial” transmission line has inner conductor of radius  $a$  and outer conductor of radius  $b$ , but the axes of these two cylinders are offset by a small distance  $\delta \ll b$ . Deduce the capacitance and inductance per unit length, and the impedance  $Z$ , accurate to order  $\delta^2/b^2$ .

The (relative) dielectric constant and permeability of the medium between the two conductors both unity. The relevant frequencies and conductivities are so large that the skin depth is small compared to  $\delta$ .



7. Cavity  $Q$ 

a) A rectangular cavity with conducting walls of length  $\Delta x = \Delta y = a$ ,  $\Delta z = l$  is excited in the (1,1,0) mode:

$$E_z = E_0 \sin \frac{\pi x}{a} \sin \frac{\pi y}{a} e^{-i\omega t}, \quad E_x = E_y + H_z = 0. \quad (10)$$

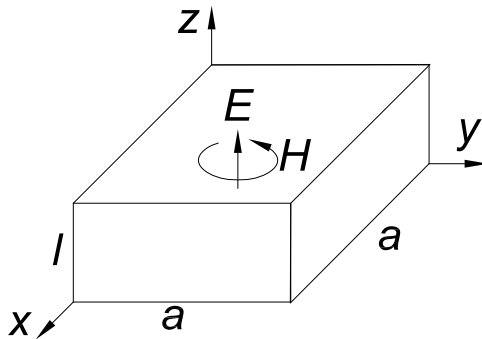

Calculate the time-averaged force on each of the six faces.

b) The cavity  $Q$  (quality factor) is defined by

$$Q = \frac{\langle \text{stored energy} \rangle}{\langle \text{energy lost per cycle} \rangle}. \quad (11)$$

Show that

$$Q = \frac{al}{2\pi d(a+2l)} \approx \frac{\text{volume}}{d \cdot \text{surface area}}, \quad (12)$$

where  $d$  is the skin depth. The approximate version of eq. (12) provides a reasonable estimate for the  $Q$  of the lowest mode of any cavity.

### 8. Cavity Line Broadening

According to the definition of cavity  $Q$  given in prob. 4,

$$\frac{dU}{dt} = -\frac{\omega_0}{2\pi Q}U, \quad (13)$$

where  $U$  is the averaged energy stored in the cavity fields, whose angular frequency is  $\omega_0$ . Thus, if the cavity were left to itself, the energy would die away:

$$U(t) = U_0 e^{-\omega_0 t / 2\pi Q}. \quad (14)$$

Since the field energy  $U$  is proportional to the square of the electric field  $E$ , we have

$$E(t) \propto E_0 e^{-\omega_0 t / 4\pi Q} e^{-i\omega_0 t}. \quad (15)$$

This is not the behavior of a pure frequency  $\omega_0$ .

Perform a Fourier analysis of the electric field:

$$E(t) = \int E_\omega e^{-i\omega t} d\omega, \quad (16)$$

supposing that the cavity is turned on at  $t = 0$ , which implies that

$$E_\omega = \frac{1}{2\pi} \int_0^\infty E(t) e^{i\omega t} dt. \quad (17)$$

Show that this leads to

$$U_\omega \propto |E_\omega|^2 \propto \frac{1}{(\omega - \omega_0)^2 + (\omega_0 / 4\pi Q)^2}, \quad (18)$$

which has the form of a **resonance curve**.

The damping due to resistive wall losses gives a finite width to the resonance: FWHM  $\Delta\omega = \omega_0 / 2\pi Q$ . Thus, the relation

$$Q = \frac{\omega_0}{2\pi \Delta\omega} \quad (19)$$

gives additional meaning to the concept of cavity  $Q$ . That is, the  $Q$  is a measure of the sharpness of the cavity frequency spectrum.

### 9. Rayleigh-Jeans Law

One of the most significant uses of a cavity was the measurement of the spectrum of the waves inside when the walls were “red hot”. Maxwell told us that if thermal equilibrium holds, each cavity mode carries energy  $kT$  (considering a mode as a kind of oscillator with two polarizations). Here,  $T$  is the temperature and  $k$  is Boltzmann’s constant.

Show that the number of modes per unit interval of angular frequency in a cubical cavity of edge  $a$  is

$$dN = \frac{a^3 \omega^2 d\omega}{\pi^2 c^3}, \quad (20)$$

for frequencies such that the mode indices  $l, m, n$  are all large compared to one.

The famous hint is that each mode  $(l, m, n)$  corresponds to a point on a cubical lattice.

Then, the energy spectrum of the cavity radiation would be

$$dE = \frac{a^3 \omega^2 kT d\omega}{\pi^2 c^3} = \frac{8\pi a^3 \nu^2 kT d\nu}{c^3}, \quad (21)$$

where  $\nu = \omega/2\pi$  is the ordinary frequency.

The Rayleigh-Jeans expression (21) implies that the total energy of the cavity radiation grows arbitrarily large as one include the contributions at high frequency.

Such behavior was, of course, not observed in the laboratory. Planck saw that this requires a rather fundamental change in our thinking...

10. **Right Circular Cavity**

A simple mode of a right circular cavity is sketched below:

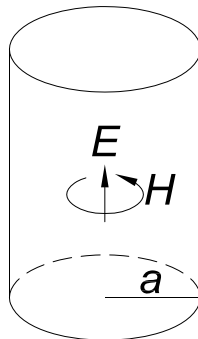

We expect that the electric field of angular frequency  $\omega$  has the form

$$\mathbf{E} = \hat{\mathbf{z}}E(r)e^{-i\omega t}. \tag{22}$$

Plugging in to the wave equation

$$\nabla^2\mathbf{E} = \frac{1}{c^2}\frac{\partial^2\mathbf{E}}{\partial t^2}, \tag{23}$$

we see that

$$\frac{1}{r}\frac{\partial}{\partial r}r\frac{\partial E}{\partial r} + \frac{\omega^2}{c^2}E = 0, \tag{24}$$

which we recognize as Bessel's equation of order zero,

$$\Rightarrow E \sim J_0\left(\frac{\omega r}{c}\right). \tag{25}$$

Alternatively, ignore the cylindrical walls initially, and simply consider the cavity to be a parallel plate capacitor. This suggests that the time-dependent electric field of angular frequency  $\omega$  has the form

$$E_z = E_0e^{-i\omega t}. \tag{26}$$

Show, however, that the time dependence of the displacement current induces an azimuthal magnetic field

$$H_\phi = -\frac{i\omega r}{2c}E_0e^{-i\omega t}. \tag{27}$$

Then, Faraday's law tells us that a correction to  $\mathbf{E}$  is induced by the time variation of  $\mathbf{H}$ ...

Follow this logic enough to demonstrate the first and second corrections to  $E_z$ , which form the first terms of the series

$$E_z = E_0e^{-i\omega t}\sum_{n=0}^{\infty}\frac{(-1)^n}{(n!)^2}\left(\frac{\omega r}{2c}\right)^{2n} = E_0J_0\left(\frac{\omega r}{c}\right)e^{-i\omega t}. \tag{28}$$

$J_0(x)$  oscillates, with zeros at  $x = 2.405, 5.520, 8.654, \dots$ . Hence, the boundary condition that  $E_z = 0$  at  $r = a$  is satisfied if

$$\frac{\omega a}{c} = 2.405, 5.520, 8.654, \dots, \tag{29}$$

which describes an important class of modes of a right circular cavity.

### 11. RF Cavity with Fields that vary Linearly with Radius

A simple rf cavity is a right circular cylinder of radius  $a$  and length  $d$  (see the preceding problem), for which the  $\text{TM}_{0,1,0}$  mode has electromagnetic fields

$$E_z(r, \theta, z, t) = E_0 J_0(kr) \cos \omega t, \quad (30)$$

$$B_\theta(r, \theta, z, t) = E_0 J_1(kr) \sin \omega t, \quad (31)$$

where  $ka = 2.405$  is the first zero of the Bessel function  $J_0$ .

Such a cavity is potentially interesting for particle acceleration in that the electric field points only along the axis and is independent of  $z$ , so that a large fraction of the maximal energy  $eEd$  could be imparted to a particle of charge  $e$  as it traverses the cavity. However, such cavities are not useful in practice for at least two reasons: the particles must pass through the cavity wall to enter or exit the cavity and thereby suffer undesirable scattering; the magnetic field does not vary linearly with radius, and so acts like a nonlinear lens for particles whose motion is not exactly parallel to the axis.

Practical accelerating cavities have apertures (irises) of radius  $b$  in the entrance and exit surfaces, so that a beam of particles can pass through without encountering any material. In this case, the electric field can no longer be purely axial. Deduce the simplest electromagnetic mode of a cavity with apertures for which the transverse components of the electric and magnetic fields vary linearly with radius. Deduce also the shape of the wall of a perfectly conducting cavity that could support this mode.

Consider a cavity of extent  $-d < z < d$ , with azimuthal symmetry and symmetry about the plane  $z = 0$ , that could be a unit cell of a repetitive structure. This implies that either  $E_z = 0$  at  $(r, z) = (0, d)$  and  $(0, -d)$ , or  $\partial E_z / \partial z = 0$  at these points.

## 12. Reflex Klystron

The figure below shows a slice through a kind of cylindrical cavity used in generation of high strength radio frequency fields, the so-called reflex klystron.

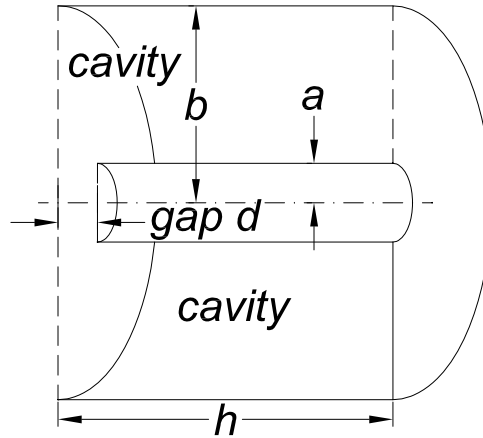

This is something like a piece of (vacuum) coaxial cable of length  $h$ , inner radius  $a$  and outer radius  $b$  terminated with a conducting plate on the right, but with a small gap  $d$  between the termination plate and the center conductor on the left. An electron beam is made to pass along the axis of the cavity through small holes. The beam is modulated at the cavity resonant frequency, and transforms its energy to the cavity field if it crosses the gap  $\approx 180^\circ$  out of phase with the cavity field.

**Estimate** the lowest resonant frequency of the cavity.

### 13. Guide Loss

Consider propagation of waves in the lowest TE mode of a rectangular waveguide with edges  $a < b$ , as shown in the figure below. The walls have conductivity  $\sigma$  and the interior of the guide is at vacuum.

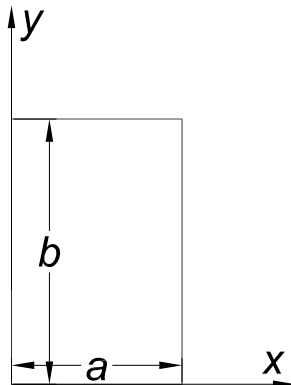

Due to Joule losses in the walls, the intensity of the propagating field dies out like  $e^{-\beta z}$  where

$$\beta = \frac{\langle \text{power loss per unit length along guide} \rangle}{\langle \text{power transmitted down the guide} \rangle}. \quad (32)$$

For waves of wavelength  $\lambda$  show that

$$\beta = \frac{c}{4\pi} \cdot \frac{4\pi}{a} \cdot \frac{1}{\sqrt{\sigma\lambda c}} \cdot \frac{1 + \frac{2a}{b} \left(\frac{\lambda}{2b}\right)^2}{\sqrt{1 - \left(\frac{\lambda}{2b}\right)^2}}, \quad (33)$$

which could be minimized to find the best choice for  $\lambda$ .

#### 14. Loop Coupling

A common way of feeding waves into a guide is shown in the figure below. The center conductor of a coaxial cable is bent into a semicircle of radius  $r$  and “grounded” on the guide wall. Then, for waves with  $r \ll \lambda$  it is a good approximation that the current  $I_0 e^{-i\omega t}$  is constant over the loop.

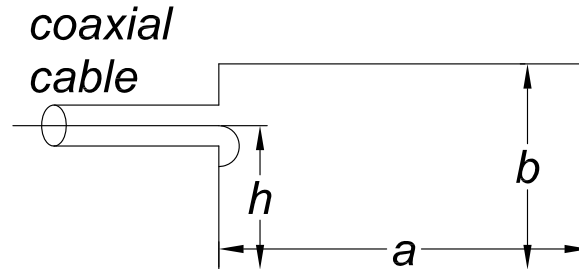

- Explain briefly why essentially no power is radiated into a TM mode by this coupler.
- If  $r \ll b < a$ , where  $a$  and  $b$  are the lengths of the edges of the guide, show that the power radiated into the lowest TE mode is

$$\langle P \rangle = \frac{4\pi}{c} I_0^2 \frac{k}{k_g} \frac{a}{b} \left( \frac{\pi r}{2a} \right)^4, \quad (34)$$

in each direction, independent of the position  $h$  of the coupling loop.



### Solutions

1. This solution is adapted from Born and Wolf, *Principles of Optics*, 7th ed., sec. 14.2. (see also Landau and Lifshitz, *The Electrodynamics of Continuous Media*, sec. 67), and finds application in the calibration of the polarization dependence of detectors for cosmic microwave background radiation (E.J. Wollack, Princeton Ph.D. dissertation, 1994, Appendix C.1.1; C. Herzog, Princeton U. Generals Expt., 1999).

In eq. (2) we need the Fresnel equations of reflection that

$$\frac{E_{0r}}{E_{0i}} \Big|_{\perp} = \frac{\sin(\theta_t - \theta_i)}{\sin(\theta_t + \theta_i)}, \quad \frac{E_{0r}}{E_{0i}} \Big|_{\parallel} = \frac{\tan(\theta_t - \theta_i)}{\tan(\theta_t + \theta_i)}, \quad (35)$$

where  $i$ ,  $r$ , and  $t$  label the incident, reflected, and transmitted waves, respectively.

The solution is based on the fact that eq. (1) holds separately for each polarization of the emitted radiation, and is also independent of the angle of the radiation. This result is implicit in Planck's derivation of Kirchhoff's law of radiation, and is stated explicitly in Reif, *Fundamentals of statistical and thermal physics*, sec. 9.14.

That law describes the thermodynamic equilibrium of radiation emitted and absorbed throughout a volume. The emissivity  $P_\nu$  and the absorption coefficient  $A_\nu$  can depend on the polarization of the radiation and on the angle of the radiation, but the definitions of polarization parallel and perpendicular to a plane of emission, and of angle relative to the normal to a surface element, are local, while the energy conservation relation  $P_\nu = A_\nu K(\nu, T)$  is global. A "ray" of radiation whose polarization can be described as parallel to the plane of emission is, in general, a mixture of parallel and perpendicular polarization from the point of view of the absorption process. Similarly, the angles of emission and absorption of a ray are different in general. Thus, the concepts of parallel and perpendicular polarization and of the angle of the radiation are not well defined after integrating over the entire volume. Thermodynamic equilibrium can exist only if a single spectral intensity function  $K(\nu, T)$  holds independent of polarization and of angle.

All that remains is to evaluate the reflection coefficients  $\mathcal{R}_\perp$  and  $\mathcal{R}_\parallel$  for the two polarizations at a vacuum-metal interface. These are well known, but we derive them for completeness.

To use the Fresnel equations (35), we need expressions for  $\sin \theta_t$  and  $\cos \theta_t$ . The boundary condition that the phase of the wave be continuous across the vacuum-metal interface leads, as is well known, to the general form of Snell's law:

$$k_i \sin \theta_i = k_t \sin \theta_t, \quad (36)$$

where  $k = 2\pi/\lambda$  is the wave number. Then,

$$\cos \theta_t = \sqrt{1 - \frac{k_i^2}{k_t^2} \sin^2 \theta_i}. \quad (37)$$

To determine the relation between wave numbers  $k_i$  and  $k_t$  in vacuum and in the conductor, we consider a plane wave of angular frequency  $\omega = 2\pi\nu$  and complex wave vector  $\mathbf{k}$ ,

$$\mathbf{E} = \mathbf{E}_0 e^{i(\mathbf{k}_t \cdot \mathbf{r} - \omega t)}, \quad (38)$$

which propagates in a conducting medium with dielectric constant  $\epsilon$ , permeability  $\mu$ , and conductivity  $\sigma$ . The wave equation for the electric field in such a medium is

$$\nabla^2 \mathbf{E} - \frac{\epsilon\mu}{c^2} \frac{\partial^2 \mathbf{E}}{\partial t^2} = \frac{4\pi\mu\sigma}{c^2} \frac{\partial \mathbf{E}}{\partial t}, \quad (39)$$

where  $c$  is the speed of light. We find the dispersion relation for the wave vector  $k_t$  on inserting eq. (38) in eq. (39):

$$k_t^2 = \epsilon\mu \frac{\omega^2}{c^2} + i \frac{4\pi\sigma\mu\omega}{c^2}. \quad (40)$$

For a good conductor, the second term of eq. (40) is much larger than the first, so we write

$$k_t \approx \frac{\sqrt{2\pi\sigma\mu\omega}}{c} (1 + i) = \frac{1 + i}{d} = \frac{2}{d(1 - i)}, \quad (41)$$

where

$$d = \frac{c}{\sqrt{2\pi\sigma\mu\omega}} \ll \lambda \quad (42)$$

is the frequency-dependent skin depth. Of course, on setting  $\epsilon = 1 = \mu$  and  $\sigma = 0$  we obtain expressions that hold in vacuum, where  $k_i = \omega/c$ .

We see that for a good conductor  $|k_t| \gg k_i$ , so according to eq. (37) we may take  $\cos \theta_t \approx 1$  to first order of accuracy in the small ratio  $d/\lambda$ . Then the first of the Fresnel equations becomes

$$\left. \frac{E_{0r}}{E_{0i}} \right|_{\perp} = \frac{\cos \theta_i \sin \theta_t / \sin \theta_i - 1}{\cos \theta_i \sin \theta_t / \sin \theta_i + 1} = \frac{(k_i/k_t) \cos \theta_i - 1}{(k_i/k_t) \cos \theta_i + 1} \approx \frac{(\pi d/\lambda)(1 - i) \cos \theta_i - 1}{(\pi d/\lambda)(1 - i) \cos \theta_i + 1}, \quad (43)$$

and the reflection coefficient is approximated by

$$\mathcal{R}_{\perp} = \left| \frac{E_{0r}}{E_{0i}} \right|_{\perp}^2 \approx 1 - \frac{4\pi d}{\lambda} \cos \theta_i = 1 - 2 \cos \theta_i \sqrt{\frac{\nu}{\sigma}}. \quad (44)$$

For the other polarization, we see that

$$\left. \frac{E_{0r}}{E_{0i}} \right|_{\parallel} = \frac{E_{0r}}{E_{0i}} \Big|_{\perp} \frac{\cos(\theta_i + \theta_t)}{\cos(\theta_i - \theta_t)} \approx \frac{E_{0r}}{E_{0i}} \Big|_{\perp} \frac{\cos \theta_i - (\pi d/\lambda)(1 - i) \sin^2 \theta_i}{\cos \theta_i + (\pi d/\lambda)(1 - i) \sin^2 \theta_i}, \quad (45)$$

so that

$$\mathcal{R}_{\parallel} \approx \mathcal{R}_{\perp} \left( 1 - \frac{4\pi d \sin^2 \theta_i}{\lambda \cos \theta_i} \right) \approx 1 - \frac{4\pi d}{\lambda \cos \theta_i} = 1 - \frac{2}{\cos \theta_i} \sqrt{\frac{\nu}{\sigma}}. \quad (46)$$

An expression for  $\mathcal{R}_{\parallel}$  valid to second order in  $d/\lambda$  has been given in Stratton, *Electromagnetic Theory*, sec. 9.9. For  $\theta_i$  near  $90^\circ$ ,  $\mathcal{R}_{\perp} \approx 1$ , but eq. (46) for  $\mathcal{R}_{\parallel}$  is not accurate. Writing  $\theta_i = \pi/2 - \vartheta_i$  with  $\vartheta_i \ll 1$ , eq. (45) becomes

$$\frac{E_{0r}}{E_{0i}} \Big|_{\parallel} \approx \frac{\vartheta_i - (\pi d/\lambda)(1-i)}{\vartheta_i + (\pi d/\lambda)(1-i)}, \quad (47)$$

For  $\theta_i = \pi/2$ ,  $\mathcal{R}_{\parallel} = 1$ , and  $\mathcal{R}_{\parallel, \min} = (5 - \sqrt{2})/(5 + \sqrt{2}) = 0.58$  for  $\vartheta_i = 2\sqrt{2}\pi d/\lambda$ .

Finally, combining eqs. (1), (2), (44) and (46) we have

$$P_{\nu\perp} \approx \frac{4\pi d \cos \theta}{\lambda^3} \frac{h\nu}{e^{h\nu/kT} - 1}, \quad P_{\nu\parallel} \approx \frac{4\pi d}{\lambda^3 \cos \theta} \frac{h\nu}{e^{h\nu/kT} - 1}, \quad (48)$$

and

$$\frac{P_{\nu\perp}}{P_{\nu\parallel}} = \cos^2 \theta \quad (49)$$

for the emissivities at angle  $\theta$  such that  $\cos \theta \gg d/\lambda$ .

The conductivity  $\sigma$  that appears in eq. (48) can be taken as the dc conductivity so long as the wavelength exceeds  $10 \mu\text{m}$ . If in addition  $h\nu \ll kT$ , then eq. (48) can be written

$$P_{\nu\perp} \approx \frac{4\pi d kT \cos \theta}{\lambda^3}, \quad P_{\nu\parallel} \approx \frac{4\pi d kT}{\lambda^3 \cos \theta}, \quad (50)$$

in terms of the skin depth  $d$ .

2. Inside a conductor the magnetic field at angular frequency  $\omega$  is related to the electric field by

$$\mathbf{H} = \frac{c}{\mu\omega d}(1+i)\hat{\mathbf{k}} \times \mathbf{E}, \quad (51)$$

where  $c$  is the speed of light,  $\mu$  is the permeability, and  $d = c/\sqrt{2\pi\sigma\mu\omega}$  is the skin depth. Hence, the time-averaged Poynting vector is

$$\langle \mathbf{S} \rangle = \frac{c^2}{8\pi\mu\omega d} |E|^2 \hat{\mathbf{k}}, \quad (52)$$

where for waves just inside the surface of the conductor  $\hat{\mathbf{k}}$  is very nearly normal to the surface.

Since  $\lambda \ll d$ , the electric field is very small inside the conductor, and Ampere's law applied to a loop of radius  $a$  gives

$$2\pi a H_0 \approx \frac{4\pi}{c} I, \quad (53)$$

or

$$\frac{2I}{ac} \approx H_0 = \frac{c}{\mu\omega d}(1+i)\hat{\mathbf{k}} \times \mathbf{E}_0. \quad (54)$$

Thus,

$$|E_0| \approx \frac{\sqrt{2}\mu\omega d |I|}{ac^2}, \quad (55)$$

and eq. (52) gives

$$\langle \mathbf{S}_0 \rangle \approx \frac{\mu\omega d}{4\pi a^2 c^2} |I|^2 \hat{\mathbf{k}}. \quad (56)$$

In terms of the effective resistance  $R$  per unit length of the wire, the average power dissipated per unit length is

$$\frac{1}{2} |I|^2 R = 2\pi a \langle \mathbf{S}_0 \rangle \approx \frac{\mu\omega d}{2ac^2} |I|^2. \quad (57)$$

Hence, we identify the effective resistance at frequency  $\omega$  as

$$R \approx \frac{\mu\omega d}{ac^2} = \frac{\mu\omega}{ac\sqrt{2\pi\sigma\mu\omega}} \cdot \frac{\sqrt{2\pi\sigma\mu\omega}}{\sqrt{2\pi\sigma\mu\omega}} = \frac{1}{2\pi ad\sigma} = \frac{a}{2d} \frac{1}{\pi a^2\sigma} = \frac{a}{2d} R_0, \quad (58)$$

where  $R_0 = 1/\pi a^2\sigma$  is the dc resistance (per unit length) of the wire to longitudinal currents.

3. Referring to the sketch, Kirchoff's rule for the circuit of length  $dz$  shown by dashed lines tells us

$$V(x) - I(Rdx) - V(x + dx) - (Ldx)\frac{\partial I}{\partial t} = 0, \quad \text{or} \quad -\frac{\partial V}{\partial x} = L\frac{\partial I}{\partial t} + IR. \quad (59)$$

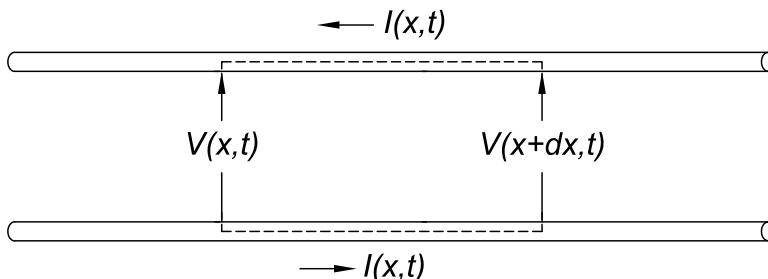

Next, the charge  $dQ$  that accumulates on length  $dx$  of the upper wire during time  $dt$  is  $(Cdx)dV$  in terms of the change of voltage  $dV$  between the wires, which also can be written in terms of currents as

$$Q = (Cdx)dV = (I(x) - I(x + dx) - I_{\text{leakage}})dt, \quad \text{so} \quad -\frac{\partial I}{\partial x} = C\frac{\partial V}{\partial t} + KV. \quad (60)$$

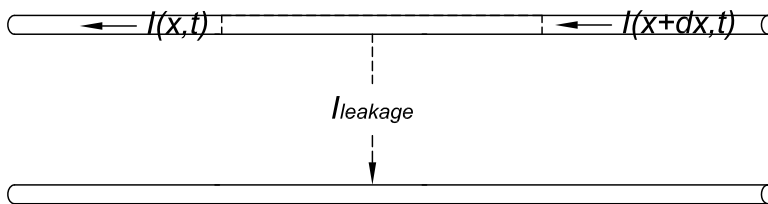

Together these imply the desired wave equation

$$\frac{\partial^2 I}{\partial x^2} = LC\frac{\partial^2 I}{\partial t^2} + (RC + KL)\frac{\partial I}{\partial t} + KRI. \quad (61)$$

We seek solutions of the form

$$I = e^{-\gamma x} f(x - vt), \quad (62)$$

for which

$$\frac{\partial I}{\partial t} = -ve^{-\gamma x} f', \quad \text{and} \quad \frac{\partial^2 I}{\partial t^2} = v^2 e^{-\gamma x} f'', \quad (63)$$

while

$$\frac{\partial I}{\partial x} = -\gamma e^{-\gamma x} f + e^{-\gamma x} f', \quad \text{so} \quad \frac{\partial^2 I}{\partial x^2} = \gamma^2 e^{-\gamma x} f - 2\gamma e^{-\gamma x} f' + e^{-\gamma x} f''. \quad (64)$$

Inserting these into the wave equation we find

$$\gamma^2 f - 2\gamma f' + f'' = v^2 LC f'' - v(RC + KL)f' + KRf. \quad (65)$$

This should be true for an arbitrary function  $f$ , so the coefficients of each derivative of  $f$  must separately be equal:

$$v = \sqrt{\frac{1}{LC}}, \quad \gamma = \sqrt{KR}, \quad \text{and} \quad 2\frac{\gamma}{v} = RC + KL = 2\sqrt{RCKL}, \quad (66)$$

where we have used the first two relations in obtaining the second form of the third. In general,  $a + b \neq 2\sqrt{ab}$ ; this only holds when  $a = b$ . So we deduce the desired condition

$$RC = KL, \quad (67)$$

for distortionless telegraphy.

With this condition, we can re-express  $\gamma$  as

$$\gamma = R\sqrt{\frac{C}{L}}. \quad (68)$$

Finally, we relate this to the impedance  $Z = V/I$  when  $R = 0 = K$ . For this, we suppose that  $V = V_0 f(x - vt)$  and  $I = I_0 f$ , where  $V_0$  and  $I_0$  can be related by either of the first-order differential equations above. We quickly find that  $V_0 = vLI_0$ , so  $Z = \sqrt{L/C}$ . Then,

$$\gamma = \frac{R}{Z}, \quad (69)$$

once we have arranged that  $RC = KL$ .

Remark: This problem was solved by O. Heaviside (1887) who argued that long-distance telegraph lines (including trans-Atlantic cables) should be designed to be ‘distortionless’. Previous cables were fairly far from this ideal. However, long cables are expensive so there was considerable hesitation to abandon the large existing capital investment and implement the proposed improvements. Indeed, the editor of the journal that published Heaviside’s papers was fired for being too sympathetic to Heaviside’s views that were initially quite unpopular with industry. Heaviside, who was unemployed for most of his life, could not be fired! Large-scale implementation of ‘distortionless’ telegraphy occurred only after 1900 following vigorous advocacy by M. Pupin of the U.S.A., for whom the physics building of Columbia U. is named.

A typical cable has  $RC \gg KL$ . It costs a lot to reduce  $RC$ , although this was the direction of industry prior to Heaviside. He noted that one shouldn’t even try to reduce leakage  $K$ , so long as the signal is not attenuated until it is undetectable – and the distortion-free condition makes it much easier to detect small signals. Rather one should increase the inductance, or leakage, or both! This counterintuitive result did not sit well with industry leaders, who, needless to say, were little guided by partial differential equations.

4. a) For a two-wire transmission line with negligible resistance, the voltage  $V$  between the wires is related to the current  $I$  in each of the wires by

$$\frac{\partial V}{\partial z} = L \frac{\partial I}{\partial t}, \quad (70)$$

which follows from Kirchhoff's law applied to a short length of the line, and

$$\frac{\partial V}{\partial t} = \frac{1}{C} \frac{\partial I}{\partial z}, \quad (71)$$

which follows from charge conservation, where  $C$  and  $L$  are the capacitance and inductance per unit length. For a wave of frequency  $\omega$  moving in the  $+z$  direction, the waveforms are

$$V = V_0 e^{i(kz - \omega t)}, \quad \text{and} \quad I = I_0 e^{i(kz - \omega t)}. \quad (72)$$

Substituting these forms into eqs. (70)-(71) we find

$$kV = -\omega LI, \quad \text{and} \quad -\omega V = \frac{kI}{C}, \quad (73)$$

and hence,

$$\frac{V}{I} = \sqrt{\frac{L}{C}} \equiv Z. \quad (74)$$

Since  $C$  and  $L$  are real numbers, the impedance  $Z$  is real in this case. This implies that  $V_0/I_0$  is also real, and so the current and voltage are in phase.

- b) When a transmission line of impedance  $Z_1$  that occupies  $z < 0$  is connected to a line of impedance  $Z_2$  for  $z > 0$ , the current and voltage will be continuous at the boundary  $z = 0$ .

An incident wave of frequency  $\omega$  from a source at  $z = -\infty$  has current  $I_i e^{i(k_1 z - \omega t)}$ . This results in a reflected wave  $I_r e^{-i(k_1 z + \omega t)}$  for  $z < 0$  and a transmitted wave  $I_t e^{i(k_2 z - \omega t)}$  for  $z > 0$ . Of course,  $V_i = Z_1 I_i$ ,  $V_r = Z_1 I_r$ , and  $V_t = Z_2 I_t$ .

Continuity of the current at  $z = 0$  tells us that

$$I_i - I_r = I_t, \quad \text{and hence} \quad V_i - V_r = \frac{Z_1}{Z_2} V_t, \quad (75)$$

since a positive value for  $I_r$  corresponds to current flowing in the  $-z$  direction.

Continuity of the voltage at  $z = 0$  tells us that

$$V_i + V_r = V_t. \quad (76)$$

Equations (75) and (76) yield

$$V_t = \frac{2Z_2}{Z_2 + Z_1} V_i, \quad \text{and} \quad V_r = \frac{Z_2 - Z_1}{Z_2 + Z_1} V_i. \quad (77)$$

At position  $z = -l$  the total voltage is

$$\begin{aligned}
 V(-l) &= V_i e^{i(-k_1 l - \omega t)} + V_r e^{-i(-k_1 l + \omega t)} = V_i e^{-i\omega t} \left( e^{-ik_1 l} + \frac{Z_2 - Z_1}{Z_2 + Z_1} e^{ik_1 l} \right) \\
 &= \frac{V_i e^{-i\omega t}}{Z_2 + Z_1} \left( (Z_2 + Z_1) e^{-ik_1 l} + (Z_2 - Z_1) e^{ik_1 l} \right) \\
 &= \frac{V_i e^{-i\omega t}}{Z_2 + Z_1} \left( Z_2 (e^{ik_1 l} + e^{-ik_1 l}) - Z_1 (e^{ik_1 l} - e^{-ik_1 l}) \right) \\
 &= \frac{2V_i e^{-i\omega t}}{Z_2 + Z_1} (Z_2 \cos k_1 l - iZ_1 \sin k_1 l), \tag{78}
 \end{aligned}$$

and (again noting that positive  $I_r$  implies a negative current) the total current is

$$\begin{aligned}
 I(-l) &= I_i e^{i(-k_1 l - \omega t)} - I_r e^{-i(-k_1 l + \omega t)} = \frac{V_i}{Z_1} e^{-i\omega t} \left( e^{-ik_1 l} - \frac{Z_2 - Z_1}{Z_2 + Z_1} e^{ik_1 l} \right) \\
 &= \frac{V_i e^{-i\omega t}}{Z_1 (Z_2 + Z_1)} \left( (Z_2 + Z_1) e^{-ik_1 l} - (Z_2 - Z_1) e^{ik_1 l} \right) \\
 &= \frac{V_i e^{-i\omega t}}{Z_1 (Z_2 + Z_1)} \left( Z_1 (e^{ik_1 l} + e^{-ik_1 l}) - Z_2 (e^{ik_1 l} - e^{-ik_1 l}) \right) \\
 &= \frac{2V_i e^{-i\omega t}}{Z_1 (Z_2 + Z_1)} (Z_1 \cos k_1 l - iZ_2 \sin k_1 l), \tag{79}
 \end{aligned}$$

Hence, we find the impedance

$$Z(-l) = \frac{V(-l)}{I(-l)} = Z_1 \frac{Z_2 \cos k_1 l - iZ_1 \sin k_1 l}{Z_1 \cos k_1 l - iZ_2 \sin k_1 l} = Z_1 \frac{Z_2 - iZ_1 \tan k_1 l}{Z_1 - iZ_2 \tan k_1 l}. \tag{80}$$

When  $l = \lambda_1/4 = \pi/2k_1$ , then  $\tan k_1 l \rightarrow \infty$  and  $Z(-l) = Z_1^2/Z_2$  is a real number, which permits the region  $\pi/2k_1 < z < 0$  of impedance  $Z_1$  to be an antireflection matching section between a line of impedance  $Z_0 = Z_1^2/Z_2$  and one of impedance  $Z_2$ .

c) A signal propagates in line 1 without reflection is that line is terminated in (real) impedance  $Z_1$ . Thus, for the circuit

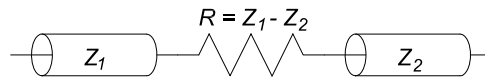

We need  $Z_1 = R + Z_2$ , since the resistor is in series with line 2 (as viewed from line 1). A proper match is possible so long as  $Z_1 > Z_2$ . The currents are the same in lines 1 and 2, so the transmitted voltage is  $V_2 = V_1 Z_2 / Z_1$ . However, this is smaller than the transmitted voltage (77) for an unmatched line, because the matching resistor dissipates more power than is “lost” to the reflection at an unmatched junction.

If  $Z_1 < Z_2$ , then a proper match to line 1 can be obtained with a resistor  $R$  in parallel with line 2, as shown below,

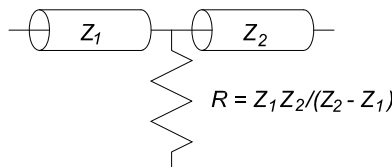



provided the effective resistance of  $R$  and  $Z_2$  is again  $Z_1$ , *i.e.*,

$$\frac{1}{Z_1} = \frac{1}{R} + \frac{1}{Z_2} \quad \Rightarrow \quad R = \frac{Z_1 Z_2}{Z_2 - Z_1}. \quad (81)$$

Here, the transmitted voltage is the same as that in line 1, but the transmitted current is less:  $I_2 = I_1 Z_1 / Z_2$ .

To match lines 1 and 2 for signals moving in either direction, a combination of the above two circuits can be used, as shown below for the case that  $Z_1 > Z_2$ :

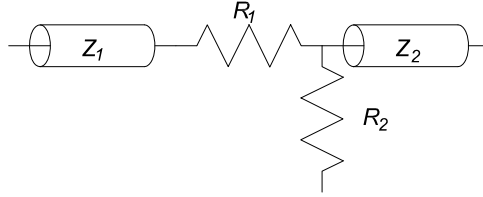

Signals emanating from line 1 must be terminated in impedance  $Z_1$ ; hence,

$$Z_1 = R_1 + \frac{R_2 Z_2}{R_2 + Z_2}. \quad (82)$$

Likewise, signals from line 2 must be terminated in impedance  $Z_2$ ; hence,

$$Z_2 = \frac{R_2 (R_1 + Z_1)}{R_1 + R_2 + Z_1}. \quad (83)$$

From eq. (82) we have

$$Z_1 Z_2 = R_1 R_2 + R_1 Z_2 - R_2 (Z_1 - Z_2), \quad (84)$$

while eq. (83) gives

$$Z_1 Z_2 = R_1 R_2 - R_1 Z_2 + R_2 (Z_1 - Z_2), \quad (85)$$

Adding eqs. (84) and (85) we find

$$Z_1 Z_2 = R_1 R_2, \quad (86)$$

while subtracting gives

$$R_1 = R_2 \frac{Z_1 - Z_2}{Z_2}. \quad (87)$$

Solving these, we find

$$R_1 = \sqrt{Z_1 (Z_1 - Z_2)}, \quad \text{and} \quad R_2 = Z_2 \sqrt{\frac{Z_1}{Z_1 - Z_2}}. \quad (88)$$

For signals emanating from line 1, the transmitted voltage is

$$V_2 = V_1 \left( 1 - \sqrt{\frac{Z_1 - Z_2}{Z_1}} \right), \quad (89)$$

while for signals emanating from line 2, the transmitted voltage is

$$V_1 = V_2 \frac{Z_1}{Z_2} \left( 1 - \sqrt{\frac{Z_1 - Z_2}{Z_1}} \right). \tag{90}$$

In both cases, the transmitted voltage is less than the incident.

For a reflectionless split of the signal in a line of impedance  $Z$  we can use the circuit:

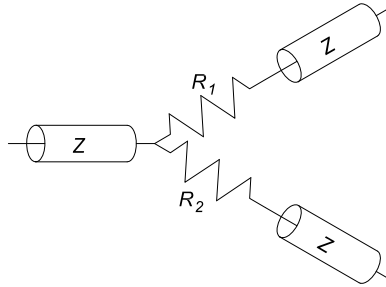

where the desired ratio of currents (and voltages) is

$$A = \frac{I_1}{I_2} = \frac{R_1 + Z}{R_2 + Z}. \tag{91}$$

Hence,

$$R_2 = AR_1 + (A - 1)Z. \tag{92}$$

Also, the two output lines must combine to terminate the input line in impedance  $Z$ , which tells us that

$$Z = \frac{(R_1 + Z)(R_2 + Z)}{R_1 + R_2 + 2Z}. \tag{93}$$

Substituting eq. (92) in (93) we find

$$R_1 = AZ, \quad \text{and} \quad R_2 = \frac{Z}{A}. \tag{94}$$

For a 50/50 split,  $A = 1$  and  $R_1 = R_2 = Z$ .

If we perform this split with three identical resistors in the symmetric configuration

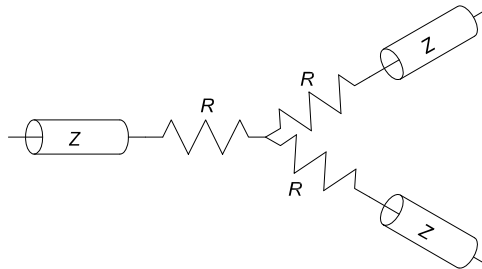

the matching condition is

$$Z = R + \frac{R + Z}{2}, \tag{95}$$

and hence,

$$R = \frac{Z}{3}. \tag{96}$$

5. As shown on p. 156 of the Notes, the inductance and capacitance per unit length of any two-conductor transmission line are related by

$$LC = \frac{\epsilon}{c^2}, \tag{97}$$

where  $c$  is the speed of light in vacuum and the medium outside the conductors is filled with a dielectric of constant  $\epsilon$ . [The permeability  $\mu$  is taken to be unity, and the frequency of the waves of interest is high enough that the skin depth is small compared to the transverse size of the conductors.] Thus, the impedance of the transmission line can be expressed as

$$Z = \sqrt{\frac{L}{C}} = \frac{\sqrt{\epsilon}}{cC} = \frac{30\sqrt{\epsilon} \Omega}{C}. \tag{98}$$

a) **Wire over Ground**

The capacitance of the wire over ground is twice the capacitance of the wire plus its image wire (since  $C = Q/\Delta V$  and  $\Delta V$  in the present example is 1/2 that for the case of two wires):

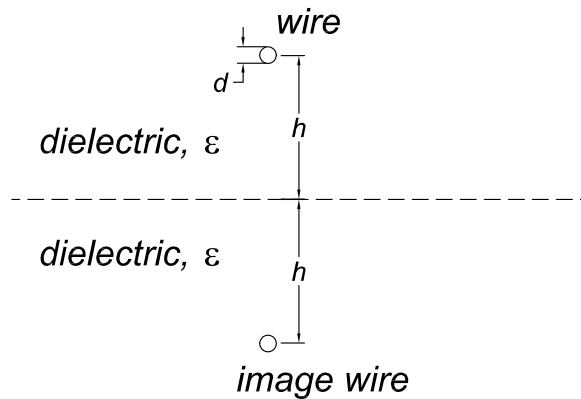

Recall prob. 11b, Set 3 to obtain the “exact” solution:

$$C = \frac{\epsilon}{2 \ln \left( \frac{2h + \sqrt{4h^2 - d^2}}{d} \right)} \approx \frac{\epsilon}{2 \ln \frac{4h}{d}}. \tag{99}$$

Here, the presence of the dielectric medium leads to the factor  $\epsilon$  in the numerator. Using the approximate form in eq. (99), which holds for  $d \ll h$ , we find

$$Z \approx \frac{60 \Omega}{\sqrt{\epsilon}} \ln \frac{4h}{d}. \tag{100}$$

The approximate result can be obtained quickly as follows. When  $d \ll h$ , the charge on the wire is distributed nearly uniformly, so we may use the result that the potential for a uniformly charged wire embedded in a medium of dielectric constant  $\epsilon$  varies as  $V(r) = 2(Q/\epsilon) \ln r$ . Thus, the potential difference between the wire of radius  $d/2$  and its image are distance  $2h$  due to charge  $Q$  per unit length on the wire is  $\Delta V \approx 2(Q/\epsilon) \ln[2h/(d/2)]$ . In evaluating the capacitance, we suppose that the image wire

has charge  $-Q$  per unit length, which doubles the potential difference between the two wires. Finally, we recall that the voltage difference between the wire and the ground plane is  $1/2$  that between the wire and its image. Hence,

$$\Delta V = 2(Q/\epsilon) \ln \frac{4h}{d} = \frac{Q}{C}, \quad (101)$$

which leads to the approximate result of eq. (99).

### b) Stripline

If the strip width  $w$  is large compared to height  $h$ , then the capacitance per unit length is roughly,

$$C \approx \frac{\epsilon w}{4\pi h}, \quad (102)$$

as follows from Gauss' law,  $\nabla \cdot \mathbf{D} = 4\pi\rho_{\text{free}}$ , and the stripline impedance is,

$$Z \approx \frac{120\pi \Omega h}{\sqrt{\epsilon} w} = \frac{377 \Omega h}{\sqrt{\epsilon} w}. \quad (103)$$

In practical circuit boards,  $w \approx h$ , and we expect the impedance to be between the estimates (103) and (100). If we use the "exact" form of eq. (99) and take  $d = h = w$ , we find,

$$C = \frac{\epsilon}{2 \ln(2 + \sqrt{3})} = \frac{\epsilon}{2.6}, \quad (104)$$

and we estimate a lower bound on the impedance to be,

$$Z \approx \frac{80 \Omega}{\sqrt{\epsilon}}. \quad (105)$$

There does not appear to be a closed-form analytic solution to the present problem, but many numerical algorithms exist. See, for example,

<http://www.ideaconsulting.com/strip.htm>

This program estimates the impedance of a stripline with  $h = w$  embedded in a thick dielectric medium to be,

$$Z \approx \frac{110 \Omega}{\sqrt{\epsilon}}. \quad (106)$$

Analytic approximations based on conformal mapping are given in sec. 5 of

[http://physics.princeton.edu/~mcdonald/examples/EM/assadourian\\_pire\\_40\\_1651\\_52.pdf](http://physics.princeton.edu/~mcdonald/examples/EM/assadourian_pire_40_1651_52.pdf)

See also sec. 11, p. 353 of

[http://physics.princeton.edu/~mcdonald/examples/EM/love\\_plms\\_22\\_337\\_24.pdf](http://physics.princeton.edu/~mcdonald/examples/EM/love_plms_22_337_24.pdf)

The case of an infinitely thin strip midway between two infinite, conducting planes can be solved analytically,

[http://physics.princeton.edu/~mcdonald/examples/EM/bates\\_iretmtt\\_4\\_28\\_56.pdf](http://physics.princeton.edu/~mcdonald/examples/EM/bates_iretmtt_4_28_56.pdf)

6. We use Gaussian units, and convert the impedance  $Z = \sqrt{L/C}$  to MKSA units by noting that  $1/c = 30\Omega$ , where  $c$  is the speed of light.

We don't need to calculate both the capacitance  $C$  per unit length and the inductance  $L$  per unit length, since in the case of a (perfectly conducting) transmission line they are related by

$$LC = \frac{\epsilon\mu}{c^2}, \tag{107}$$

where the dielectric constant  $\epsilon$  and the permeability  $\mu$  are unity in the present case. The assumed smallness of the skin depth permits us to approximate the present transmission line as perfectly conducting.

We first present two calculations of the capacitance (secs. a and b), and then a calculation of the inductance (sec. c) as illustrations of various possible techniques.

**a) The Capacitance Via the Image Method**

It is expedient to use the image method for 2-dimensional cylindrical geometries. Recall that in the case of a wire of charge  $q$  per unit length at distance  $b$  from a ground conducting cylinder of radius  $a$ , as shown in the figure, one can think of an image wire of charge  $-q$  at radius  $a^2/b$ .

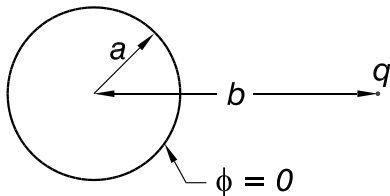

To apply this to the present problem, sketched in the figure below, note that the image wires of charge  $\pm q$  per unit length are both located to the left of the center of the inner conductor, say at distances  $r_a$  and  $r_b$ .

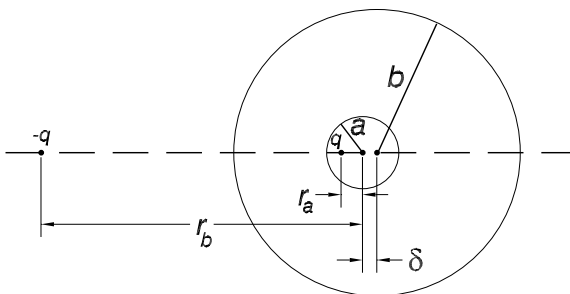

For the inner cylinder to be an equipotential, we must have

$$r_b = \frac{a^2}{r_a}, \tag{108}$$

and the outer cylinder is also an equipotential provided

$$r_b + \delta = \frac{b^2}{r_a + \delta}, \tag{109}$$

noting the offset by  $\delta$  between the inner and outer cylinder. Combining eqs. (108) and (109), and noting that  $r_a \rightarrow 0$  as  $\delta \rightarrow 0$ , we find

$$r_a = \frac{b^2 - a^2 - \delta^2 - \sqrt{(b^2 - a^2 - \delta^2)^2 - 4a^2\delta^2}}{2\delta}. \quad (110)$$

The capacitance is related by  $C = q/\Delta V$ , where  $\Delta V = V_b - V_a$  is the potential difference between the two cylinders. Recall that the potential at distance  $r$  from a wire of charge  $q$  per unit length is  $2q \ln r + \text{constant}$ . We evaluate the potentials at the points where the cylinders are closest to one another:

$$V_a = 2q \ln(a - r_a) - 2q \ln(r_b - a) = 2q \ln \frac{a - r_a}{a^2/r_a - a} = 2q \ln \frac{r_a}{a}, \quad (111)$$

using eq. (108), and

$$V_b = 2q \ln(b - \delta - r_a) - 2q \ln(r_b - b + \delta) = 2q \ln \frac{b - r_a - \delta}{b^2/(r_a + \delta) - b} = 2q \ln \frac{r_a + \delta}{b}, \quad (112)$$

using eq. (109). Then,

$$\Delta V = 2q \ln \left[ \frac{a}{b} \left( 1 + \frac{\delta}{r_a} \right) \right]. \quad (113)$$

When combined with eq. (110), this is an “exact” solution for any  $\delta < b - a$ . In particular, as  $\delta \rightarrow b - a$ , then  $r_a \rightarrow a$ , and the cylinders touch with the result that  $\Delta V = 0$ .

Here, we suppose that  $\delta \ll b - a$ , and expand  $\delta/r_a$  to second order:

$$\frac{\delta}{r_a} = \frac{b^2 - a^2 - \delta^2 + \sqrt{(b^2 - a^2 - \delta^2)^2 - 4a^2\delta^2}}{2a^2} \approx \frac{b^2 - a^2}{a^2} - \frac{b^2\delta^2}{a^2(b^2 - a^2)}, \quad (114)$$

so that

$$1 + \frac{\delta}{r_a} \approx \frac{b^2}{a^2} \left( 1 - \frac{\delta^2}{b^2 - a^2} \right). \quad (115)$$

The capacitance per unit length is therefore,

$$C = \frac{q}{\Delta V} \approx \frac{1}{2 \left( \ln \frac{b}{a} - \frac{\delta^2}{b^2 - a^2} \right)}, \quad (116)$$

using eq. (113).

The inductance per unit length now follows from eq. (107):

$$L = \frac{2}{c^2} \left( \ln \frac{b}{a} - \frac{\delta^2}{b^2 - a^2} \right), \quad (117)$$

and the impedance is

$$Z = \sqrt{\frac{L}{C}} \approx \frac{2}{c} \left( \ln \frac{b}{a} - \frac{\delta^2}{b^2 - a^2} \right) = 60 \left( \ln \frac{b}{a} - \frac{\delta^2}{b^2 - a^2} \right) \Omega. \quad (118)$$

Remark: The “exact” expression (113) is often written in a different fashion, which is convenient for large  $\delta$ , but perhaps less useful for small  $\delta$ . The “exact” version of (114) leads to

$$1 + \frac{\delta}{r_a} = \frac{b^2 + a^2 - \delta^2 + \sqrt{(b^2 + a^2 - \delta^2)^2 - 4a^2b^2}}{2a^2}, \tag{119}$$

which in turn leads to

$$C = \frac{q}{\Delta V} = \frac{1}{2 \ln \frac{b^2 + a^2 - \delta^2 + \sqrt{(b^2 + a^2 - \delta^2)^2 - 4a^2b^2}}{2ab}} = \frac{1}{2 \cosh^{-1} \frac{a^2 + b^2 - \delta^2}{2ab}}. \tag{120}$$

**b) Capacitance Via Series Expansion of the Potential**

The image method can be deduced by an application of series expansion techniques for the electrostatic potential. In this section, we explore a direct use of such techniques. A full solution is long, and when we leave off some steps at the end, we get an answer that is not quite correct.

We define the electrostatic potential  $\phi$  to be zero on the inner conductor,

$$\phi(r = a) = 0, \tag{121}$$

and  $V$  on the outer conductor whose surface is approximately given by  $r = b + \delta \cos \theta$ ,

$$\phi(r = b + \delta \cos \theta) = V. \tag{122}$$

The potential is symmetric about  $\theta = 0$ :

$$\phi(-\theta) = \phi(\theta), \tag{123}$$

so terms in  $\sin n\theta$  cannot appear in the series expansion of the potential:

$$\phi(r, \theta) = A_0 \ln r + \sum_{n=1} \left( A_n r^n + \frac{B_n}{r^n} \right) \cos n\theta. \tag{124}$$

The capacitance  $C$  per unit length is, of course, given by  $C = Q/V$ , where the charge  $Q$  per unit length on the inner conductor is given by

$$Q = 2\pi a \int_0^{2\pi} \sigma(\theta) d\theta = 2\pi a \int_0^{2\pi} \frac{E_r(a, \theta)}{4\pi} d\theta = \frac{a}{2} \int_0^{2\pi} \frac{\partial \phi(a, \theta)}{\partial r} d\theta = \frac{A_0}{2}. \tag{125}$$

Thus,

$$C = \frac{A_0}{2V}. \tag{126}$$

Applying the boundary condition (121) to the general form (124), we have

$$0 = A_0 \ln a + \sum_{n=1} \left( A_n a^n + \frac{B_n}{a^n} \right) \cos n\theta. \tag{127}$$

Likewise, the boundary condition (122) yields

$$V = A_0 \ln(b + \delta \cos \theta) + \sum_{n=1} \left( A_n (b + \delta \cos \theta)^n + \frac{B_n}{(b + \delta \cos \theta)^n} \right) \cos n\theta. \quad (128)$$

With considerable effort, the terms in eq. (128) of the form  $\cos^l \theta \cos m\theta$  can be expressed as sums of terms in the orthogonal set of functions  $\cos n\theta$ . Then, eqs. (127) and (128) can be combined to yield the Fourier coefficients  $A_n$  and  $B_n$ . Thus, subtracting eq. (127) from (128) and using the approximation (140), we have

$$V = A_0 \left( \ln \frac{b}{a} + \frac{\delta \cos \theta}{b} - \frac{\delta^2 \cos^2 \theta}{2b^2} \right) + F(A_n, B_n, \theta) \quad (129)$$

If the integral of  $F$  with respect to  $\theta$  vanished, then integrating eq. (129) yields

$$V = A_0 \left( \ln \frac{b}{a} - \frac{\delta^2}{4b^2} \right), \quad (130)$$

and the capacitance would be

$$C = \frac{A_0}{2V} \approx \frac{1}{2 \left( \ln \frac{b}{a} - \frac{\delta^2}{4b^2} \right)}. \quad (131)$$

However, the presence of terms like  $A_1 \cos^2 \theta$  in  $F$  means that we cannot expect its integral to vanish, and eq. (131) is not quite correct.

### c) Calculation of the Inductance

The calculation of the inductance is complicated by the fact that the currents in this problem are distributed over surfaces, rather than flowing in filamentary wires. We would like to use the relation,

$$\Phi = cLI, \quad (132)$$

where  $I$  is the total (steady) current flowing down the inner conductor (and back up the outer conductor), and  $\Phi$  is the magnetic flux per unit length linked by the circuit. From Ampere's law, with the assumption that the currents are uniformly distributed on the inner and outer conductors, the azimuthal component  $B_\theta$  of the magnetic field in the region between the two conductors is given by

$$B_\theta(r) = \frac{2I}{cr}. \quad (133)$$

If the cable were truly coaxial, the flux would be simply

$$\Phi_0 = \int_a^b B_\theta dr = \frac{2I}{c} \ln \frac{b}{a}, \quad (134)$$

and the corresponding inductance would be

$$L_0 = \frac{2}{c^2} \ln \frac{b}{a}. \quad (135)$$



Then, from eq. (107) the capacitance would be

$$C_0 = \frac{1}{2 \ln(b/a)}, \tag{136}$$

as is readily verified by an electrostatic analysis, and the transmission line impedance would be

$$Z_0 = \sqrt{\frac{L_0}{C_0}} = \frac{2}{c} \ln \frac{b}{a} = 60 \ln \frac{b}{a} \Omega. \tag{137}$$

However, because the outer conductor is off center with respect to the inner, we cannot simply use eq. (134). We can segment the currents on the conductors into filaments of azimuthal extent  $d\theta$ , and calculate the flux  $\Phi(\theta)$  linked the circuit element defined by the segments centered on angle  $\theta$  on the inner and outer conductors. Then, the effective inductance of the whole cable can be estimated from eq. (132) using the average of  $\Phi(\theta)$ :

$$L = \frac{1}{2\pi cI} \int_0^{2\pi} \Phi(\theta) d\theta = \frac{1}{2\pi cI} \int_0^{2\pi} d\theta \int_a^{r_{\max}(\theta)} B_\theta(r) dr = \frac{1}{\pi c^2} \int_0^{2\pi} \ln \frac{r_{\max}(\theta)}{a} d\theta, \tag{138}$$

using (133) and (134). The result holds only to the extent that the current distribution is independent of azimuth, as discussed in sec. d. However, there will be a small azimuthal dependence to the current in this problem, so we will not obtain a completely correct result.

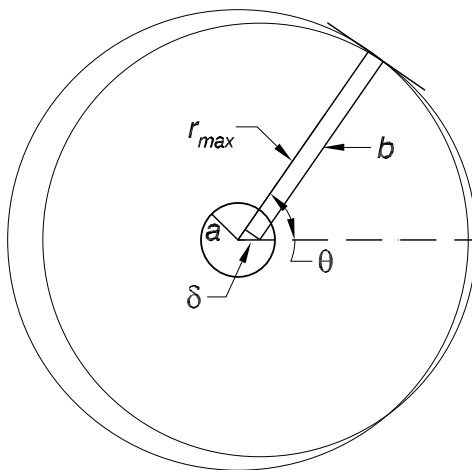

To complete the analysis, we need  $r_{\max}(\theta)$ , the maximum radius about the center of the inner conductor of magnetic field lines that are linked by the segment of the outer conductor at azimuthal angle  $\theta$ . Assuming the currents is uniformly distributed over the inner and outer conductors, the magnetic field between the two conductors is entirely due to the current in the inner conductor, and the field is purely azimuthal about the axis of the inner conductor as given by eq. (133). Then, the geometry shown in the figure tells us that

$$r_{\max}(\theta) = b + \delta \cos \theta. \tag{139}$$

This relation is “exact” to the extent that the currents are uniformly distributed; however, this is not actually the case in the present problem.

To use relation (139) in eq. (138), we approximate

$$\ln \frac{r_{\max}(\theta)}{a} = \ln \frac{b + \delta \cos \theta}{a} = \ln \frac{b}{a} + \ln \left( 1 + \frac{\delta \cos \theta}{b} \right) \approx \ln \frac{b}{a} + \frac{\delta \cos \theta}{b} - \frac{\delta^2 \cos^2 \theta}{2b^2}, \quad (140)$$

which leads to

$$L \approx \frac{2}{c^2} \left( \ln \frac{b}{a} - \frac{\delta^2}{4b^2} \right). \quad (141)$$

This result happens to agree with the result implied by sec. b, but differs somewhat from the more accurate result of sec. a.

#### d) The Magnetic Flux Linked by a Distributed Circuit

The magnetic flux through a filamentary circuit (one in which the conductors are idealized as wires) is well defined as

$$\Phi = \int \mathbf{B} \cdot d\mathbf{S}, \quad (142)$$

where the integral is taken over any surface bounded by the circuit. However, when the conductors of the circuit are distributed and have a finite cross sectional area  $A$ , then eq. (142) is not well defined.

We wish to show that a consistent definition of the flux through a distributed circuit is obtained by segmenting the conductors into a large number of circuits each with very small cross sectional area  $A_i$ , and defining

$$\Phi = \frac{1}{A} \sum_i A_i \Phi_i, \quad (143)$$

where the magnetic flux through subcircuit  $i$  is given by eq. (142).

We are interested in a definition of flux that gives consistency to the relation (132) in the context of circuit analysis. In particular, if the circuit has total resistance  $R$ , and the magnetic flux is changing, then we desire Faraday’s law to be written as

$$IR = \mathcal{E} = -\frac{1}{c} \frac{d\Phi}{dt}, \quad (144)$$

which is the same form as holds for each of the filamentary subcircuits:

$$I_i R_i = \mathcal{E}_i = -\frac{1}{c} \frac{d\Phi_i}{dt}. \quad (145)$$

We suppose that the current flowing in subcircuit  $i$  is related to the total current according to

$$I_i = \frac{A_i}{A} I, \quad (146)$$

in which case the resistance of subcircuit  $i$  is given by

$$R_i = \frac{A}{A_i} R. \quad (147)$$

Then, we can combine eqs. (145)-(147) as

$$I = \sum_i I_i = -\frac{1}{c} \sum_i \frac{1}{R_i} \frac{d\Phi_i}{dt} = -\frac{1}{cRA} \sum_i A_i \frac{d\Phi_i}{dt}. \quad (148)$$

Hence, the definition (143) leads to the desired relation (144) for the distributed circuit.

7. a) The force on the cavity walls can be evaluated via the Maxwell stress tensor. Recall that for a good conductor the electric field is perpendicular to a conducting surface, and the magnetic field is parallel. Also, the Maxwell stress associated with a perpendicular field  $\mathbf{E}$  is  $+E^2/8\pi$ , while that with a parallel field  $\mathbf{H}$  is  $-H^2/8\pi$ . That is, the total, time-averaged force on a face of the cavity is given by

$$\langle F \rangle = \frac{1}{2} \int_{\text{face}} \frac{|E|^2 - |H|^2}{8\pi} d\text{Area}. \quad (149)$$

A positive value of  $F$  corresponds to an inward force.

The electromagnetic fields of the (1,1,0) mode are

$$E_x = 0, \quad (150)$$

$$E_y = 0, \quad (151)$$

$$E_z = E_0 \sin \frac{\pi x}{a} \sin \frac{\pi y}{a} e^{-i\omega t}, \quad (152)$$

$$H_x = -i \frac{E_0}{\sqrt{2}} \sin \frac{\pi x}{a} \cos \frac{\pi y}{a} e^{-i\omega t}, \quad (153)$$

$$H_y = -i \frac{E_0}{\sqrt{2}} \cos \frac{\pi x}{a} \sin \frac{\pi y}{a} e^{-i\omega t}, \quad (154)$$

$$H_z = 0, \quad (155)$$

using eq. (10), Faraday's law

$$\nabla \times \mathbf{E} = -\frac{1}{c} \frac{\partial \mathbf{H}}{\partial t}, \quad (156)$$

and the wave equation

$$\nabla^2 \mathbf{E} = \frac{1}{c^2} \frac{\partial^2 \mathbf{H}}{\partial t^2}, \quad (157)$$

which latter tells us that

$$2 \frac{\pi^2}{a^2} = \frac{\omega^2}{c^2}. \quad (158)$$

The force on each of the four faces perpendicular to the  $x$  or  $y$  axes is the same by the symmetry of the problem, and can be calculated using the face at, say,  $x = 0$  to be

$$\langle F \rangle = -\frac{1}{16\pi} \int_0^a dy \int_0^l dz |H_y|^2 = -\frac{alE_0^2}{64\pi}. \quad (159)$$

This force is outwards.

Likewise, the force on the two faces perpendicular to the  $z$  axis is the same, and is

$$\langle F \rangle = \frac{1}{16\pi} \int_0^a dx \int_0^a dy (|E_z|^2 - |H_x|^2 - |H_y|^2) = 0. \quad (160)$$

- b) Turning to the cavity  $Q$ , we first calculate the time-averaged energy  $U$  in the cavity:

$$\langle U \rangle = \frac{1}{2} \int d\text{Vol} \frac{|E|^2 + |H|^2}{8\pi} = \frac{a^2 l E_0^2}{32\pi}. \quad (161)$$

The energy lost per cycle into the walls is the time-averaged power loss  $\langle P \rangle$  times the period  $T = 2\pi/\omega$ .

The power  $\langle P \rangle$  lost in the cavity walls can be calculated by evaluating the component of the (time-averaged) Poynting vector perpendicular to the walls:

$$\begin{aligned}\langle P \rangle &= \int \langle \mathbf{S} \rangle_{\perp \text{ to walls}} d\text{Area} = \frac{c}{8\pi} \int \text{Re}(\mathbf{E} \times \mathbf{H}^*)_{\perp \text{ to walls}} d\text{Area} \\ &= \frac{c}{8\pi} \int \text{Re}(\mathbf{E}_{\parallel} \times \mathbf{H}_{\parallel}^*) d\text{Area}.\end{aligned}\quad (162)$$

If the fields were actually those specified by eqs. (150)-(155), which assume perfect conductors, the power lost to the walls would be zero. For a good, but not perfect, conductor, it is an excellent approximation to suppose the cavity magnetic field is that given by the perfect-conductor approximation, eqs. (153)-(155), but to take the electric field near the conducting walls as having a small parallel component given by

$$\mathbf{E}_{\parallel \text{ at the walls}} = -\frac{\omega d}{2c}(1-i)\hat{\mathbf{n}} \times \mathbf{H}_{\parallel}, \quad (163)$$

where

$$d = \frac{c}{\sqrt{2\pi\sigma\omega}} \quad (164)$$

is the skin depth at frequency  $\omega$  for the walls of conductivity  $\sigma$ , and  $\hat{\mathbf{n}}$  is the outward normal vector. This relation follows from the 4th Maxwell equation, evaluated just inside the surface of the conductor where  $\mathbf{J} = \sigma\mathbf{E}$ ,

$$\nabla \times \mathbf{H} = \frac{4\pi}{c}\mathbf{J} + \frac{1}{c}\frac{\partial \mathbf{E}}{\partial t} = \frac{4\pi\sigma}{c}\mathbf{E} + \frac{1}{c}\frac{\partial \mathbf{E}}{\partial t} \approx \frac{4\pi\sigma}{c}\mathbf{E}, \quad (165)$$

the curl of which yields,

$$\nabla^2 \mathbf{H} \approx \frac{4\pi\sigma}{c^2} \frac{\partial \mathbf{H}}{\partial t}, \quad (166)$$

where the approximations are valid for a good conductor. [This diffusion equation, due to Lord Kelvin, was the basis of time-dependent electrodynamics in the era shortly before Maxwell clarified that if  $\sigma = 0$  then waves can propagate with speed  $c$  without diffusionlike distortion. It is amazing from a modern perspective that the first telegraph systems were successfully constructed using eq. (166) as their theoretical model.]

Inside the conductor, and for waves of frequency  $\omega$  and wave vector  $\mathbf{k}$  of the form  $e^{i(\mathbf{k}\cdot\mathbf{x}-\omega t)}$ , eq. (166) becomes

$$k^2 \approx \frac{4\pi i\sigma\omega}{c^2}, \quad (167)$$

so that

$$k \approx \frac{\sqrt{4\pi\sigma\omega}}{c} \frac{1+i}{\sqrt{2}} \equiv \frac{1+i}{d}. \quad (168)$$

Then, the Maxwell equation (165) becomes

$$i\mathbf{k} \times \mathbf{H} \equiv ik\hat{\mathbf{n}} \times \mathbf{H} \approx \frac{4\pi\sigma}{c}\mathbf{E}, \quad (169)$$

which can also be written as eq. (163).

Inserting eq. (163) into (162), we find the general expression

$$\langle P \rangle = \frac{\omega d}{16\pi} \int |H_{\parallel}|^2 d\text{Area}. \quad (170)$$

Evaluating this for the present example, we find

$$\langle P \rangle_{\text{into walls}} = \frac{\omega d E_0^2}{32\pi} (a^2 + 2al). \quad (171)$$

The energy lost per cycle is  $\langle P \rangle T = 2\pi \langle P \rangle / \omega$ , so the cavity  $Q$  is

$$Q = \frac{\langle U \rangle}{\langle P \rangle} \frac{\omega}{2\pi} = \frac{al}{2\pi d(a + 2l)} = \frac{\text{volume}}{\pi d \cdot \text{surface area}}. \quad (172)$$

8. Given the electric field

$$E(t) = E_0 e^{-\omega_0 t / 4\pi Q} e^{-i\omega_0 t}, \quad t > 0, \quad (173)$$

its Fourier components are given by

$$\begin{aligned} E_\omega &= \frac{1}{2\pi} \int_0^\infty E(t) e^{i\omega t} dt = \frac{E_0}{2\pi} \int_0^\infty e^{i(\omega - \omega_0 + i\omega_0 / 4\pi Q)t} dt \\ &= \frac{iE_0}{2\pi} \frac{1}{\omega - \omega_0 + i\omega_0 / 4\pi Q}, \end{aligned} \quad (174)$$

where we ignore the oscillatory contribution associated with the limit  $t \rightarrow \infty$ .

The Fourier analysis of the stored energy  $U$  therefore behaves as

$$U_\omega \propto |E_\omega|^2 \propto \frac{1}{(\omega - \omega_0)^2 + (\omega_0 / 4\pi Q)^2}. \quad (175)$$

9. The electric field of a standing wave mode of angular frequency  $\omega$  inside a cubical cavity of edge  $a$  has components of the form

$$E_x = E_0 \cos \frac{l\pi x}{a} \sin \frac{m\pi y}{a} \sin \frac{n\pi z}{a} e^{-i\omega t}, \quad (176)$$

*etc.* The wave equation,

$$\nabla^2 \mathbf{E} = \frac{1}{c^2} \frac{\partial^2 \mathbf{E}}{\partial t^2}, \quad (177)$$

yields the dispersion relation

$$k = \frac{\pi}{a} \sqrt{l^2 + m^2 + n^2} = \frac{\omega}{c}. \quad (178)$$

This leads to the interpretation that a mode  $(l, m, n)$  has a wave vector  $\mathbf{k}$  whose components are

$$\frac{\pi}{a}(l, m, n). \quad (179)$$

The modes populate a cubical lattice in the first octant of  $\mathbf{k}$ -space, with  $\pi/a$  as the lattice constant. For  $l$ ,  $m$ , and  $n$  large, the number of modes in interval  $d\omega$  about frequency  $\omega = kc$  is equal to  $(a/\pi)^3$  times the volume of a shell of thickness  $dk = d\omega/c$  in the first octant of  $\mathbf{k}$ -space – times two since there are two possible polarization of the electric field for each set of indices  $(l, m, n)$ .

Thus,

$$dN = 2 \cdot \frac{a^3}{\pi^3} \cdot \frac{1}{8} \cdot 4\pi(\omega/c)^2(d\omega/c) = \frac{a^3\omega^2 d\omega}{\pi^2 c^3}. \quad (180)$$

Jeans' contribution to this result was to note that only indices in the first octant correspond to physical modes, and therefore Rayleigh's original calculation was to be divided by 8.



10. Given the zeroth order electric field of a right circular cavity,

$$E_{z,(0)} = E_0 e^{-i\omega t}, \quad (181)$$

we integrate the 4th Maxwell equation around a loop of radius  $r$  in the  $x$ - $y$  plane to find the first correction to the (initially zero) magnetic field,

$$\oint \mathbf{H}_{(1)} \cdot d\mathbf{l} = 2\pi r H_{\phi,(1)} = \frac{1}{c} \int \frac{\partial \mathbf{E}_{z,(0)}}{\partial t} \cdot d\mathbf{S} = -\frac{i\omega\pi r^2}{c} E_0 e^{-i\omega t}, \quad (182)$$

so that

$$H_{\phi,(1)} = -\frac{i\omega r}{2c} E_0 e^{-i\omega t}. \quad (183)$$

Next, we consider a loop in the  $x$ - $z$  plane that includes the  $z$  axis and the line  $x = r$ , for which Faraday's law tells us that

$$\oint \mathbf{E}_{(1)} \cdot d\mathbf{l} = -h E_{z,(1)} = -\frac{1}{c} \int \frac{\partial \mathbf{H}_{\phi,(1)}}{\partial t} \cdot d\mathbf{S} = \frac{\omega^2 h r^2}{4c^2} E_0 e^{-i\omega t}, \quad (184)$$

so that

$$E_{z,(1)} = -\frac{\omega^2 r^2}{4c^2} E_0 e^{-i\omega t}. \quad (185)$$

We now iterate, first using a loop of radius  $r$  in the  $x$ - $y$  plane to find

$$\oint \mathbf{H}_{(2)} \cdot d\mathbf{l} = 2\pi r H_{\phi,(2)} = \frac{1}{c} \int \frac{\partial \mathbf{E}_{z,(1)}}{\partial t} \cdot d\mathbf{S} = \frac{i\omega^3 \pi r^4}{4c^3} E_0 e^{-i\omega t}, \quad (186)$$

so that

$$H_{\phi,(2)} = \frac{i\omega^3 r^3}{8c^3} E_0 e^{-i\omega t}. \quad (187)$$

Again, we consider a loop in the  $x$ - $z$  plane that includes the  $z$  axis and the line  $x = r$ , for which Faraday's law tells us that

$$\oint \mathbf{E}_{(2)} \cdot d\mathbf{l} = h E_{z,(2)} = -\frac{1}{c} \int \frac{\partial \mathbf{H}_{\phi,(2)}}{\partial t} \cdot d\mathbf{S} = \frac{\omega^4 h r^4}{16c^4} E_0 e^{-i\omega t}, \quad (188)$$

so that

$$E_{z,(2)} = \frac{\omega^4 r^4}{16c^4} E_0 e^{-i\omega t}. \quad (189)$$

Thus,

$$E_z = E_0 e^{-i\omega t} \left( 1 - \frac{\omega^2 r^2}{4c^2} + \frac{\omega^4 r^4}{16c^4} - \dots \right) = E_0 e^{-i\omega t} \sum_{n=0}^{\infty} \frac{(-1)^n}{(n!)^2} \left( \frac{\omega r}{2c} \right)^{2n} = E_0 J_0 \left( \frac{\omega r}{c} \right) e^{-i\omega t}. \quad (190)$$

11. We seek a standing wave solution where, say, the time dependence of  $E_z$  is  $\cos \omega t$ . The cavity is symmetric about the plane  $z = 0$ , so we expect the  $z$  dependence of  $E_z$  to have the form  $\cos k_n z$ , where

$$k_n = \begin{cases} (2n - 1)\pi/2d, & \text{if } E_z(0, -d) = E_z(0, d) = 0, \\ n\pi/d, & \text{if } \partial E_z(0, -d)/\partial z = \partial E_z(0, d)/\partial z = 0. \end{cases} \quad (191)$$

We can combine these two cases in the notation

$$k_n = (2n - n_0)\frac{\pi}{2d}, \text{ where } \begin{cases} n_0 = 1, & \text{if } E_z(0, -d) = E_z(0, d) = 0, \\ n_0 = 2, & \text{if } \partial E_z(0, -d)/\partial z = \partial E_z(0, d)/\partial z = 0. \end{cases} \quad (192)$$

where  $n = 1, 2, 3, \dots$

Our trial solution,

$$E_z(r, z, t) = f_n(r) \cos k_n z \cos \omega t, \quad (193)$$

must satisfy the wave equation

$$\nabla^2 E_z - \frac{1}{c^2} \frac{\partial^2 E_z}{\partial t^2} = \frac{1}{r} \frac{\partial}{\partial r} \left( \frac{r \partial f_n}{\partial r} \right) - \left( k_n^2 - \frac{\omega^2}{c^2} \right) f_n = 0. \quad (194)$$

This is the differential equation for the modified Bessel function of order zero,  $I_0(K_n r)$ , where

$$K_n^2 = k_n^2 - \frac{\omega^2}{c^2} = \left[ (2n - n_0)\frac{\pi}{2d} \right]^2 - \left( \frac{2\pi}{\lambda} \right)^2, \quad (195)$$

the free-space wavelength at frequency  $\omega$  is  $\lambda = 2\pi c/\omega$ , and

$$I_0(x) = 1 + (x/2)^2 + \frac{(x/2)^4}{(2!)^2} + \frac{(x/2)^6}{(3!)^2} + \dots \quad (196)$$

In the special case of  $k_n = 0$ , eq. (194) reverts to that for the ordinary Bessel function  $J_0$ , and the fields (30)-(31) are obtained. Since this form cannot exist in a cavity with apertures, we ignore it in further discussion.

A Fourier series for  $E_z$  with nonzero  $k_n$  is then

$$E_z(r, z, t) = \sum_{n=1}^{\infty} a_n I_0(K_n r) \cos k_n z \cos \omega t. \quad (197)$$

The radial component of the electric field is obtained from

$$\nabla \cdot \mathbf{E} = \frac{1}{r} \frac{\partial r E_r}{\partial r} + \frac{\partial E_z}{\partial z} = 0, \quad (198)$$

so that

$$\begin{aligned} E_r(r, z, t) &= \frac{1}{r} \sum_n a_n k_n \int r I_0(K_n r) dr \sin k_n z \cos \omega t \\ &= \frac{r}{2} \sum_n a_n k_n \tilde{I}_1(K_n r) \sin k_n z \cos \omega t, \end{aligned} \quad (199)$$

using the fact that  $d(xI_1)/dx = xI_0$ , and where

$$\tilde{I}_1(x) = \frac{2I_1(x)}{x} = 1 + \frac{(x/2)^2}{1!2!} + \frac{(x/2)^4}{2!3!} + \dots \quad (200)$$

The azimuthal component of the magnetic field is obtained from

$$(\nabla \times \mathbf{E})_\theta = \frac{\partial E_r}{\partial z} - \frac{\partial E_z}{\partial r} = -\frac{1}{c} \frac{\partial B_\theta}{\partial t}, \quad (201)$$

so that

$$\begin{aligned} B_\theta(r, z, t) &= \frac{c}{\omega} \sum_n a_n \left( \frac{dI_0(K_n r)}{dr} - \frac{k_n^2 r}{2} \tilde{I}_1(K_n r) \right) \cos k_n z \sin \omega t \\ &= \frac{\pi r}{\lambda} \sum_n a_n \tilde{I}_1(K_n r) \cos k_n z \sin \omega t, \end{aligned} \quad (202)$$

using the fact that  $I'_0(x) = I_1(x)$ .

We desire that the transverse fields  $E_r$  and  $B_\theta$  vary linearly with  $r$ . According to eqs. (199)-(200) and (202), this requires that  $K_n = 0$ . The simplest choice is  $n = 1$ ,  $n_0 = 1$ , so that  $k_n = \pi/2d$  and  $d = \lambda/4$ . The fields are

$$E_z = E_0 \cos \frac{\pi z}{2d} \cos \omega t, \quad (203)$$

$$E_r = \frac{\pi r}{4d} E_0 \sin \frac{\pi z}{2d} \cos \omega t, \quad (204)$$

$$B_\theta = \frac{\pi r}{4d} E_0 \cos \frac{\pi z}{2d} \sin \omega t. \quad (205)$$

The cavity length is  $2d = \lambda/2$ , and  $E_z$  vanishes on axis at the ends of the cavity. This configuration is called the  $\pi$  mode in accelerator physics. Since  $E_r(z = \pm d) \neq 0$ , this mode cannot exist in a structure with conducting walls at the planes  $z = \pm d$ ; apertures are required.

The electric field is perpendicular to the walls of a perfectly conducting cavity. Expressing the shape of the walls as  $r(z)$ , we then have

$$\frac{dr}{dz} = -\frac{E_z}{E_r} = -\frac{4d}{\pi r} \cot \frac{\pi z}{2d}, \quad (206)$$

which integrates to the form

$$r^2 = b^2 - \left( \frac{4d}{\pi} \right)^2 \ln \left| \sin \frac{\pi z}{2d} \right|, \quad (207)$$

where  $b$  is the radius of the apertures at  $z = \pm d$ . Near  $z = \pm d$ , the profile is a hyperbola. Since  $r \rightarrow \infty$  as  $z \rightarrow 0$ , no real cavity can support the idealized fields (203)-(205). However, it turns out that a cavity with maximum radius  $a = 0.4d$  has a Fourier expansion (197) where  $a_2 = 0.15a_1$ , so the fields can be a good approximation to eqs. (203)-(205) in real devices.

We can obtain additional formal solutions in which  $K_n = 0$  for any value of  $n$ , and for  $n_0$  either 1 or 2. However, these solutions are not really distinct from eqs. (203)-(205), but are simply the result of combining any number of  $\lambda/2$  cells into a larger structure. Such multicell  $\pi$ -mode structures are difficult to operate in practice, because the strong coupling of the fields from one cell to the next makes the useful range of drive frequencies extremely narrow. The main application of  $\pi$ -mode cavities is for so-called rf guns, in which a half cell has a surface at  $z \approx 0$  suitable for laser-induced photoemission of electrons, which are then accelerated further in one or a few more subsequent cells. See K.T. McDonald, *Design of the Laser-Driven RF Electron Gun for the BNL Accelerator Test Facility*, IEEE Trans. Electron Devices, **35**, 2052 (1988).<sup>1</sup>

---

<sup>1</sup>[http://physics.princeton.edu/~mcdonald/examples/EM/mcdonald\\_ieeted\\_35\\_2052\\_88.pdf](http://physics.princeton.edu/~mcdonald/examples/EM/mcdonald_ieeted_35_2052_88.pdf)

12. An estimate of the lowest rf frequency of the reflex klystron cavity can be made via an equivalent  $LC$  circuit:

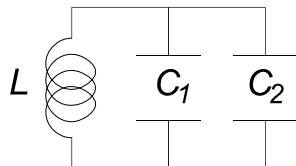

$$\omega \approx \frac{1}{\sqrt{LC}} = \frac{1}{\sqrt{L(C_1 + C_2)}}, \tag{208}$$

where  $C_1$  is the capacitance between the left termination plate and the disc of radius  $a$  at the left end of the center conductor,  $C_2$  is the capacitance between the inner and outer conductor, and  $L$  is the self inductance between the inner and outer conductor. The capacitances  $C_1$  and  $C_2$  are in parallel, and so are added to yield the total capacitance  $C$ .

$C_1$  is estimated by the usual parallel-plate formula,

$$C_1 \approx \frac{\text{Area}}{4\pi \cdot \text{height}} = \frac{a^2}{4d}. \tag{209}$$

$C_2$  is estimated by the capacitance of length  $h - d$  of a coaxial cable,

$$C_2 \approx \frac{h - d}{2 \ln b/a}. \tag{210}$$

The main interest in this type of cavity is for small gap  $d$ , so we write

$$C = C_1 + C_2 \approx \frac{a^2}{4d} \left( 1 + \frac{2dh}{a^2 \ln b/a} \right). \tag{211}$$

$L$  is estimated by the inductance of length  $h - d \approx h$  of a coaxial cable,

$$L \approx \frac{h - d}{c^2 [C_2 / (h - d)]} \approx \frac{2h \ln b/a}{c^2}, \tag{212}$$

recalling that the product of the capacitance per unit length and the inductance per unit length of a transmission line (in vacuum) is  $1/c^2$ .

The lowest cavity frequency is then estimated to be

$$\omega \approx \frac{1}{\sqrt{LC}} \approx \frac{c}{a} \sqrt{\frac{2d}{h(1 + 2dh/a^2 \ln b/a) \ln b/a}}. \tag{213}$$

For  $d$  small enough, we can neglect the capacitance  $C_2$ , and eq. (213) simplifies to

$$\omega \approx \frac{1}{\sqrt{LC}} \approx \frac{c}{a} \sqrt{\frac{2d}{h \ln b/a}} \quad (d \ll a^2/h). \tag{214}$$

This result is small compared to  $\omega = \pi c/h$ , the resonant frequency of a terminated coaxial cable of length  $h$ , which shows that it is possible to obtain low cavity frequencies without large cavity size.

The book *Klystrons and Microwave Triodes* by Princetonian D.R. Hamilton (Dover, 1966) quotes (p. 75) a numerical analysis of the reflex klystron (dating from 1934) as claiming that  $\omega = 0.3c/a$  when  $b/a = 3$ ,  $h/a = 3$ , and  $d/a = 0.32$ . Equation (213) yields  $\omega \approx 0.44c/a$  for these values, in reasonable agreement.

Note that the simple coaxial cavity is not the limit of the reflex klystron cavity as  $d \rightarrow 0$ , since  $C_1 \rightarrow \infty$  in that case. Rather, the coaxial cavity obtains when  $C_1$  and  $d$  are both set to zero, in which case eq. (213) gives the estimate  $\omega \approx c/h$ , which is a factor of  $\pi$  smaller than the “exact” result.

13. The electric field of a TE mode in a rectangular waveguide of edges  $a < b$  has the form

$$E_x = E_0 \cos \frac{m\pi x}{a} \sin \frac{n\pi y}{b} e^{i(k_g z - \omega t)}, \quad (215)$$

$$E_y = E_0 \sin \frac{m\pi x}{a} \cos \frac{n\pi y}{b} e^{i(k_g z - \omega t)}, \quad (216)$$

$$E_z = 0, \quad (217)$$

where the guide wave number  $k_g$  is found from the wave equation to obey

$$\omega = c \sqrt{k_g^2 + \left(\frac{m\pi}{a}\right)^2 + \left(\frac{n\pi}{b}\right)^2}. \quad (218)$$

The lowest frequency mode has indices  $m = 0, n = 1$ , for which only  $E_x$  is nonzero.

The magnetic field of this mode follows from Faraday's law,

$$\nabla \times \mathbf{E} = -\frac{1}{c} \frac{\partial \mathbf{H}}{\partial t} = \frac{i\omega \mathbf{H}}{c}, \quad (219)$$

so that

$$H_x = 0, \quad (220)$$

$$H_y = \frac{ck_g}{\omega} E_0 \sin \frac{\pi y}{b} e^{i(k_g z - \omega t)}, \quad (221)$$

$$H_z = \frac{ic\pi}{\omega b} E_0 \cos \frac{\pi y}{b} e^{i(k_g z - \omega t)}, \quad (222)$$

and

$$k_g = \sqrt{\frac{\omega^2}{c^2} - \frac{\pi^2}{b^2}} = \frac{\omega}{c} \sqrt{1 - \left(\frac{\lambda}{2b}\right)^2}. \quad (223)$$

The time-averaged power transmitted down the guide follows from the Poynting vector,

$$\begin{aligned} \langle P \rangle_{\text{transmitted}} &= \int \langle S_z \rangle dx dy = \frac{c}{8\pi} \int E_x H_y^* dx dy = \frac{c^2}{16\pi} ab \frac{k_g}{\omega} E_0^2 \\ &= \frac{c}{16\pi} ab E_0^2 \sqrt{1 - \left(\frac{\lambda}{2b}\right)^2}. \end{aligned} \quad (224)$$

To find the time-averaged power loss in the walls, we recall the argument of prob. 4, which led to the general result (170),

$$\langle P \rangle_{\text{lost in walls}} = \frac{\omega d}{16\pi} \int |H_{\parallel}|^2 d\text{Area}, \quad (225)$$

where  $d = c/\sqrt{2\pi\sigma\omega}$  is the skin depth. For the present example, the power lost into the walls per unit length along the guide is

$$\begin{aligned} \langle P \rangle_{\text{lost}} &= 2 \frac{\omega d}{16\pi} \left( \int_0^a |H_z(x, 0, z)|^2 dx + \int_0^b [ |H_y(0, y, z)|^2 + |H_z(0, y, z)|^2 ] dy \right) \\ &= \frac{\omega d}{8\pi} E_0^2 \left( \frac{c^2 \pi^2}{\omega^2 b^2} a + \left[ \frac{c^2 k_g^2}{\omega^2} + \frac{c^2 \pi^2}{\omega^2 b^2} \right] \frac{b}{2} \right) = \frac{\omega d}{8\pi} E_0^2 \left( \frac{c^2 \pi^2}{\omega^2 b^2} a + \frac{b}{2} \right) \\ &= \frac{bc}{16\pi} \sqrt{\frac{c}{\sigma \lambda}} E_0^2 \left( 1 + \frac{2a}{b} \left(\frac{\lambda}{2b}\right)^2 \right). \end{aligned} \quad (226)$$

Finally, the attenuation factor  $\beta$  is given by

$$\beta = \frac{\langle P \rangle_{\text{lost}}}{\langle P \rangle_{\text{trans}}} = \frac{1}{a} \sqrt{\frac{c}{\sigma \lambda}} \frac{1 + \frac{2a}{b} \left(\frac{\lambda}{2b}\right)^2}{\sqrt{1 - \left(\frac{\lambda}{2b}\right)^2}} = \frac{c}{4\pi} \cdot \frac{4\pi}{a} \cdot \sqrt{\frac{1}{c\sigma\lambda}} \cdot \frac{1 + \frac{2a}{b} \left(\frac{\lambda}{2b}\right)^2}{\sqrt{1 - \left(\frac{\lambda}{2b}\right)^2}}. \quad (227)$$



14. a) The current in the semicircular loop creates a magnetic field that has a component along the axis of the guide. Since TM modes have no longitudinal magnetic field, the field of the loop does not couple to these modes.

b) It is “derived” on pp. 170-171 of the Notes that an oscillatory, transverse current distribution  $\mathbf{J}$  inside a waveguide excites a waveguide mode with normalized electric field  $\mathbf{E}_0$  to strength

$$\mathbf{E} = -\frac{2\pi}{c} Z \mathbf{E}_0 \int \mathbf{J} \cdot \mathbf{E}_{0\perp} d\text{Area}, \tag{228}$$

where  $Z = k/k_g$  for TE modes and  $Z = k_g/k$  for TM modes.

Comparing with prob. 9, the lowest TE mode in the present problem ( $0 < x < a$ ,  $0 < y < b < a$ ) has

$$\mathbf{E}_0 = \sqrt{\frac{2}{ab}} \sin \frac{\pi x}{a} \hat{\mathbf{y}}, \tag{229}$$

where the normalization condition is  $\int E_0^2 d\text{Area} = 1$ .

Since the electric field of this mode is independent of  $y$ , the excitation of this mode by the loop current will be independent of the position of the loop in  $y$ .

Taking  $\theta$  to measure the angle around the semicircular loop, we have

$$\begin{aligned} \int \mathbf{J} \cdot \mathbf{E}_{0\perp} d\text{Area} &= -\int_0^\pi r d\theta I_0 E_0 \sin \theta = -r I_0 \sqrt{\frac{2}{ab}} \int_0^\pi d\theta \sin \frac{\pi r \sin \theta}{a} \sin \theta \\ &\approx -\frac{\pi r^2}{a} I_0 \sqrt{\frac{2}{ab}} \int_0^\pi d\theta \sin^2 \theta = -\frac{\pi^2 r^2}{a} \frac{I_0}{\sqrt{2ab}}, \end{aligned} \tag{230}$$

where the approximation holds for  $r \ll a$ . The wave numbers are related by

$$k_g = \sqrt{\frac{\omega^2}{c^2} - \frac{\pi^2}{a^2}} = k \sqrt{1 - \left(\frac{\lambda}{2a}\right)^2} \tag{231}$$

According to eqs. (228)-(229), the strength of the field in the lowest TE mode is

$$\mathbf{E} = \frac{2\pi}{c} \frac{k}{k_g} \frac{\pi^2 r^2}{a} \frac{I_0}{ab} \sin \frac{\pi x}{a} \hat{\mathbf{y}}, \tag{232}$$

The (time-averaged) power in the lowest TE mode follows from the Poynting vector,

$$\begin{aligned} \langle P \rangle_{\text{trans}} &= \int \langle S_z \rangle dx dy = \frac{c}{8\pi Z} \int E_\perp^2 dx dy = \frac{\pi}{4c} \frac{k}{k_g} \left(\frac{\pi^2 r^2}{a}\right)^2 \frac{I_0^2}{ab} \\ &= \frac{4\pi}{c} \frac{k}{k_g} \left(\frac{\pi r}{2a}\right)^4 I_0^2 \frac{a}{b} = \frac{4\pi}{c} \left(\frac{\pi r}{2a}\right)^4 \frac{I_0^2}{\sqrt{1 - \left(\frac{\lambda}{2a}\right)^2}} \frac{a}{b}. \end{aligned} \tag{233}$$

This calculation holds for TE waves excited in either direction down the guide.

As usual, to convert this result from Gaussian to SI units, simply replace  $4\pi/c$  by  $377 \Omega$ .